



United States
Department of
Agriculture

Office of
Transportation

Agricultural
Handbook
Number 668

Tropical Products Transport Handbook

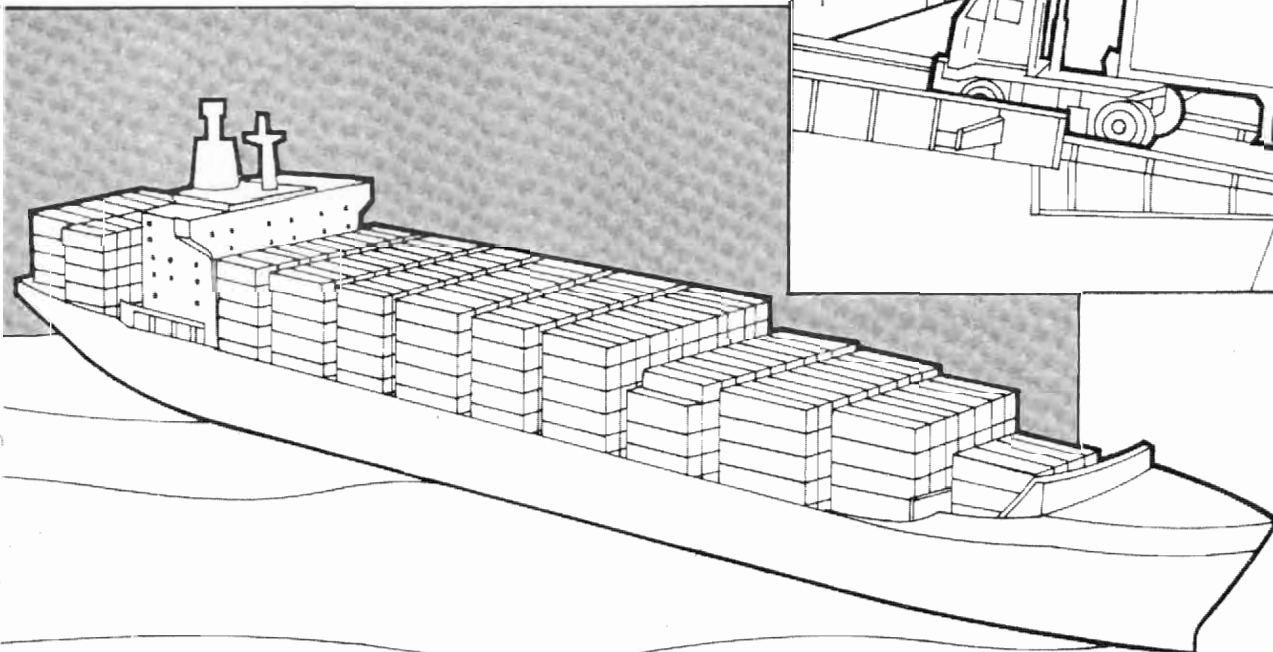
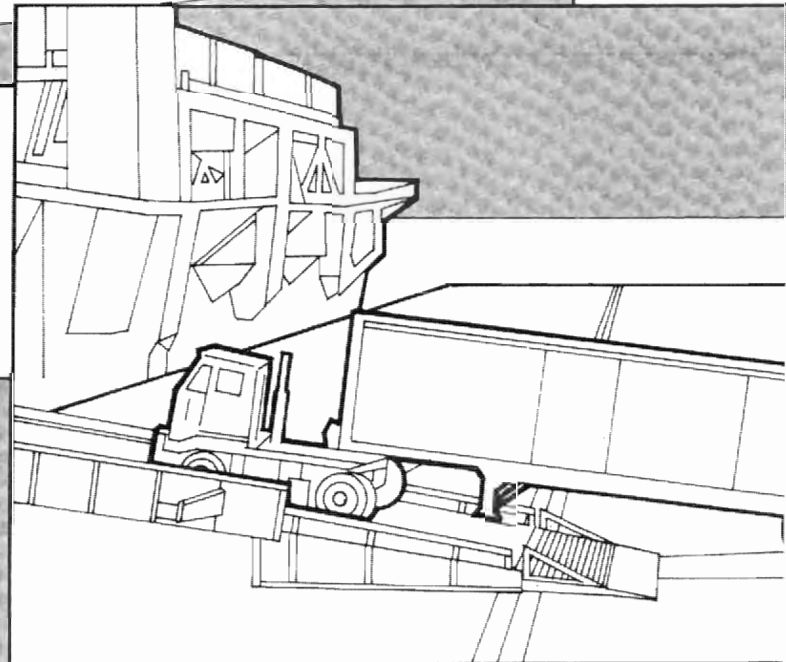
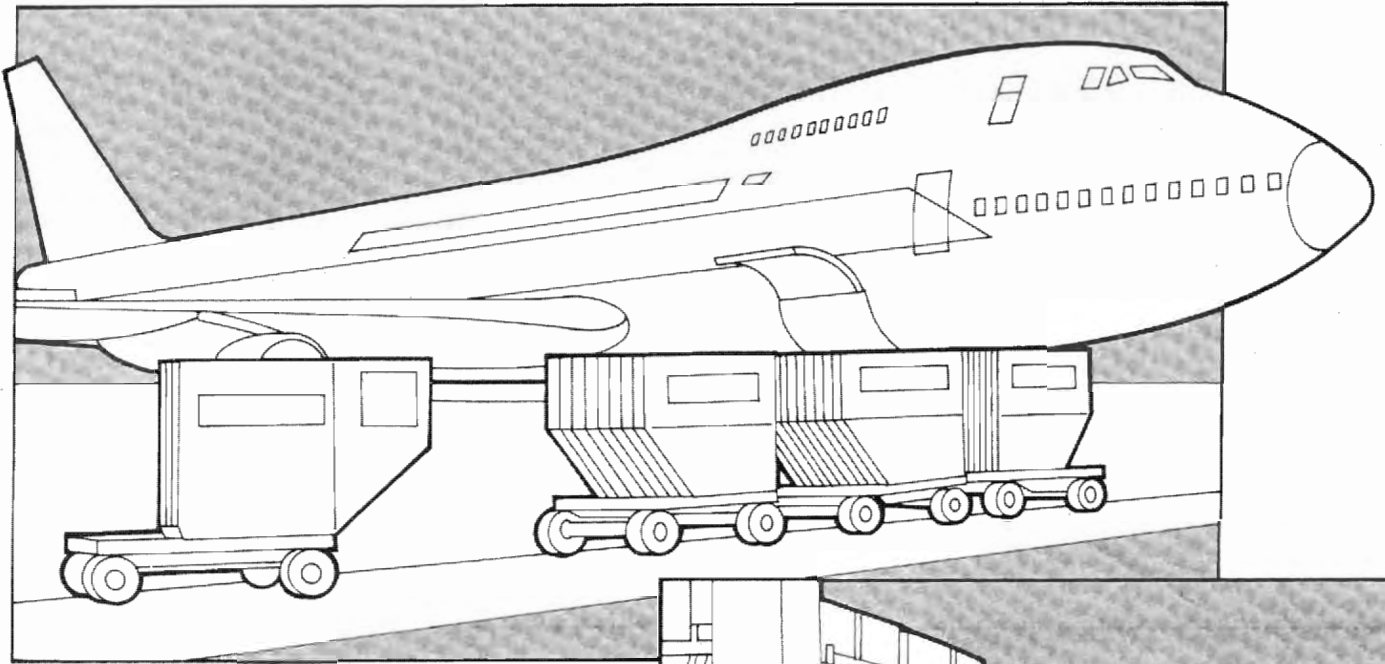

Abstract

McGregor, Brian M. 1987. Tropical Products Transport Handbook. U.S. Department of Agriculture, Agriculture Handbook No. 668. p. 148.

This handbook takes a broad approach to maintenance of quality of fruits, vegetables, plants, and flowers during transportation. In that regard, proper planning, grading, packaging, and precooling practices are emphasized as these are particularly important for crops shipped long distances from areas with tropical and subtropical climates. The handbook also discusses the choice of mode of transportation, checking the transport equipment before loading, loading practices, and recommended transit and storage procedures. A summary of facts and recommendations is given for 120 fruits and vegetables, most of these being tropical in origin. Specific information also is given for potted plants, and cut flowers and florist greens.

Keywords: air cargo, air circulation, availability, chilling injury, commodity storage, compatibility, ethylene sensitivity, freezing injury, grading, inspections, labeling, loading, mixed loads, modified atmosphere, moisture loss, odor sensitivity, packaging, precooling, quality, receiving, refrigeration, relative humidity, respiration rates, sanitation, standardization, storage, temperature, temperature recorders, treatments, transportation, transport equipment, unit loads, ventilation.

August 1987
Slightly revised,
September 1989

Mention of companies or commercial products does not imply recommendation or endorsement by the U.S. Department of Agriculture over others not mentioned.

**United States
Department of
Agriculture**

Office of
Transportation

Agriculture
Handbook No. 668

Tropical Products Transport Handbook

**By
Brian M. McGregor
Agricultural Marketing Specialist
Export Services Branch
U.S. Department of Agriculture
Office of Transportation
Washington, DC 20250-4500**

Acknowledgments

This handbook was funded by the U.S. Agency for International Development through the Private Sector Relations Division of the Office of International Cooperation and Development, U.S. Department of Agriculture.

The detailed research conducted over the years by individuals in the U.S. Department of Agriculture, State departments of agriculture, universities, colleges, and industry was instrumental in the development of this handbook. Readers are urged to obtain many of the listed references for further details on grading, packaging, precooling, transporting, and storing fruits, vegetables, plants, and cut flowers which are produced in tropical and subtropical areas of the world.

The author is grateful to individuals in the USDA and private industry who provided comments on the draft manuscript, including B. Hunt Ashby (USDA-OT); R. Tom Hinsch (USDA-ARS); Lawrence A. Risse (USDA-ARS); Karl E. Hoke (USDA-OT); Betsy Nordin (USDA-APHIS); David L. Priester (USDA-AMS); William Armellini (Armellini Express Lines, Inc.); Judi E. Greening (Frieda's Finest Produce Specialties, Inc.); Dick Kwiatkowski (Union Camp Corp.); and Stephen Tavilla (P. Tavilla Co). This enabled substantial improvements to the text.

The following persons provided photographs for the text: William L. Craig (USDA-OT); B. Hunt Ashby (USDA-OT); William Dunton (USDA-OT); Constantine J. Nicholas (USDA-OT); Lawrence A. Risse (USDA-ARS); and James R. Hutton (Semco Manufacturing Co.). William L. Craig also provided the illustrations.

Contents

Subject	Page
Introduction	viii
Plan Ahead Before Growing and Shipping	1
Transport Only Top Quality Products	2
Ensure Quality Control With Grading	3
Grading Practices	3
Grade Standards	4
Official Inspections	4
Maintain Quality With Effective Packaging	6
Materials	6
Fiberboard Box Styles	7
Methods	10
Types of Packs	10
What Packaging Must Withstand	11
Standardization	30
Unit Loads	34
Pallets	35
Slipsheets	40
Labeling and Branding	40
Precool Produce To Ensure Quality	41
Factors	41
Methods	42
Precautions	43
Precooling Equipment	44
Choose The Best Mode of Transport	46
Factors	46
Equipment	47
Refrigeration Systems	47
Insurance	48
Design Features	48
Transport Equipment	49
Check The Transport Equipment Before Loading	56

Subject	Page
Use Proper Loading Practices	57
Methods	57
Air Circulation	57
Temperature Control	57
Bracing	58
Pest Control	58
Air Cargo Equipment	58
Trailers and Van Containers	58
Top Air Delivery	59
Bottom Air Delivery	61
Top Icing	61
Temperature Recorders	62
Mixed Loads	62
Multi-Temperature Loads	62
Modified Atmosphere Loads	63
Ventilation	63
Loaded Equipment	63
 Use Recommended Transit and Storage Procedures	 66
Mixed Loads and Storage	66
Compatibility Groups	67
Chill Sensitivity	70
Freeze Sensitivity	70
Moisture Loss Sensitivity	70
Ethylene Sensitivity	72
Odor Sensitivity	72
Receiving Procedures	73
Air Circulation and Sanitation	73
 Tropical and Subtropical Fruits and Vegetables, and Specialty Products	 74
Amaranth	76
Anise	76
Artichokes	76
Asian Pear	77
Asparagus	77
Atemoya	77
Avocado	78
Babaco	79
Baby Vegetables	79
Bananas	80
Barbados Cherry	80
Bean Sprouts	80
Beans	81

Subject	Page
Belgian Endive	81
Bitter Melon	82
Black Sapote	82
Blood Orange	82
Bok Choy	83
Boniato	83
Breadfruit	83
Broccoli	84
Brussels Sprouts	84
Cactus Leaves	84
Cactus Pears	85
Caimito	85
Calabaza	85
Calamondin	85
Canistel	86
Cantaloupe	86
Carambola	86
Carrots	87
Cashew Apple	87
Cauliflower	87
Celeriac	88
Celery	88
Chayote Squash	88
Cherimoya	89
Chinese Broccoli	89
Chinese Cabbage	89
Chinese Long Bean	90
Clementine	90
Coconut	90
Corn	91
Cucumbers	91
Custard Apple	91
Daikon	92
Durian	92
Eggplant	92
Feijoa	93
Figs	93
Granadilla	93
Ginger Root	93
Grapefruit	94
Grapes	94
Guava	95
Haricot Vert	95
Horseradish	95
Jaboticaba	95

Subject	Page
Jackfruit	96
Jaffa Orange	96
Japanese Eggplant	96
Jerusalem Artichoke.....	96
Jicama	97
Kiwano	97
Kiwifruit	97
Kohlrabi.....	98
Kumquat.....	98
Leeks	98
Lemon.....	99
Lime.....	99
Lo Bok	99
Longan.....	99
Loquat.....	100
Lychee	100
Malanga	100
Mamey	100
Mango.....	101
Mangosteen	101
Melons	101
Okra.....	102
Oranges	102
Papaya.....	103
Passionfruit	103
Pepino.....	103
Peppers.....	104
Persimmon.....	104
Pineapple.....	104
Plantain.....	105
Pomegranate.....	105
Pummelo.....	105
Pumpkin.....	106
Quince	106
Raddichio.....	106
Rhubarb	107
Salsify	107
Sapodilla	107
Scorzonera.....	107
Seedless Cucumbers	108
Snow Peas.....	108
Squash.....	108
Strawberries.....	109
Sugar Apple.....	109

Subject	Page
Tamarillo	110
Tamarind.....	110
Tangerines	110
Taro Root.....	111
Tomatillos.....	111
Tomatoes	111
Ugli Fruit	112
Waterchestnut.....	112
Watercress.....	112
Watermelon.....	113
White Asparagus.....	113
White Sapote	113
Winged Bean	113
Yam	114
Yucca Root	114
Potted Flowering and Foliage Plants	119
Cuttings.....	119
Treatments.....	120
Packaging	120
Transportation	122
Cut Flowers and Florist Greens	126
Treatments.....	126
Packaging	127
Refrigeration	129
Transportation.....	130
Storage	131
Appendix 1	135
U.S. Regulations and Sources of Information	
Appendix 2	140
List of U.S. Grade Standards and Inspection Instructions	
List of References	147

Introduction

The purpose of this handbook is to provide transportation recommendations for fruits and vegetables, live plants, and cut flowers produced in tropical and subtropical as well as areas with temperate climates. Guidelines on grading, packaging, precooling, and storage are included, because transportation is merely one part of an integral system of maintaining product quality from the field to the consumer. In order to emphasize the essentials of successful transportation of these perishable products, the information is presented in a brief manner with many illustrations. A summary of information is provided for the products that are listed in the table of contents.

The market for tropical fruits and vegetables and specialties has expanded beyond Asian, Hispanic, and other ethnic communities as individuals have become more interested in their personal health, food preparation, and variety in their diet. An increasingly wider choice of fresh products is available in food stores and fancy restaurants, thanks to the marketing efforts of members of the produce industry. Many of these products are in consumers hands within 2 days of harvest in another part of the world. Transportation and packaging are the key to this success.

Advances in transportation and packaging also have helped to increase the availability of potted plants and exotic cut flowers. Consumers now purchase these items from roadside vendors and in food stores as well as traditional flower shops and nurseries. Plants and flowers are increasingly used to brighten up businesses and homes.

The regions of the world which produce the largest variety and year-round supply of these products have tropical or subtropical climates. Many of the items covered in this book are only produced in these areas. Most of the general recommendations in this handbook, however, apply to all perishable agricultural products, wherever and whenever they are produced. Advances in greenhouse management, irrigation, biotechnology, and transportation have increased flexibility in the location of production areas.

The areas which produce the most perishable products—California, Florida, Texas, Arizona, Hawaii, Puerto Rico, Mexico, Central America, the Caribbean, South America, and Southeast Asia—face marketing challenges due to their distance from the major markets of Eastern and Central United States, Canada, the Far East or Europe. That is why the emphasis of this handbook is on maintaining product quality through proper handling, packaging, transportation, and storage—from the field to the consumer.

Plan Ahead Before Growing and Shipping

Agriculture is a very competitive, risky business. To minimize risk, growers and shippers must plan ahead and obtain as much information as possible. Communication with government authorities, importers, and carriers is necessary; both before growing tropical fruits and vegetables, plants, and cut flowers; and thereafter. The grower and shipper must determine the following:

- Is the product permitted to enter the destination country, region or State?
- Is there a market for the product?
- What are the requirements for quantity, quality, packaging, documentation, and frequency of shipments?
- Will the projected price received cover production, packaging, transportation, insurance, and marketing costs and allow for a profit?
- Will the right kind of transportation equipment be available when the product is ready for shipping?

The U.S. Department of Agriculture (USDA), Animal and Plant Health Inspection Service (APHIS) provides information on regulations governing the entry of foreign products to the United States and vice versa. Almost all plant products must have a permit in order to enter the United States. Some countries require a phytosanitary certificate for U.S. products. Permits and certificates are issued only to the U.S. importer or U.S. exporter. Appendix 1 provides an outline of all U.S. Government regulatory and market information.

Growers and shippers should visit with importers to ascertain their reliability and obtain firsthand market information on product quantity, quality, packaging, pricing, and regulations. Most importers will not deal with a shipper who proves to be unreliable in terms of timing, volume, quality, or documentation.

Communication with importers and the firms that monitor their financial status should be maintained throughout the year. Timely and accurate information is necessary to minimize the risks of shipping the wrong product or shipping the right product at the wrong time.

Cost information should be obtained from suppliers of equipment, packaging, and other materials. Freight rates should be negotiated with carriers. This information can then be compared to projected production costs and estimated product prices. This will allow an estimate to be made of the potential profit and loss in the venture.

Air and ocean carriers request that shippers consult with them well in advance to ensure that the necessary equipment will be available at the right time, with freight rates at a level the product can support. Most carriers are willing to work with shippers to try to make a deal work. Shippers can form associations to negotiate time and volume rates with ocean carriers. Port authorities and trade publications of origin and destination countries are the best sources of current information on services provided by competing air and ocean carriers.

Transport Only Top Quality Products

Under the best circumstances, the quality of fruits, vegetables, live plants, and cut flowers can only be maintained, not improved, during transportation. Most of these products are high-value and very perishable. Therefore product quality should be the highest possible.

Products in top quality condition:

- have a longer shelf life.
- allow more time for transportation, storage, and marketing.
- satisfy importers, brokers, and consumers.
- increase repeat sales and profits.
- help expand markets.

Bruised, decaying, or overripe products can ruin an entire shipment and reduce an importer's confidence in the grower and shipper. Products in this condition:

- spread decay to other products in the load.
- produce more ethylene gas which causes further ripening and decay.
- produce more heat (respiration) which causes further ripening and decay.
- lose more water which results in shriveling and wilting.
- discourage repeat sales.
- reduce profits.

During transportation, storage, and marketing, products may be exposed to:

- rough handling during loading and unloading.
- compression from the overhead weight of other containers of products.
- impact and vibration during transportation.
- loss of moisture to the surrounding air.
- higher than recommended temperatures.
- lower than recommended temperatures.
- ethylene gas from vehicle exhaust or product ripening.
- odors from other products or residues.

By selecting and packing only top quality products, shippers can help ensure good arrival condition of fruits and vegetables, plants, and cut flowers transported over long distances. Grading, good packaging, precooling, and proper transportation equipment are essential to maintaining product quality from the field to the consumer.

Ensure Quality Control With Grading

Importers and consumers of fruits and vegetables, plants, and cut flowers demand high quality fresh products in return for the high prices they pay. Growers and shippers should use the buyer's specifications for grading to monitor quality, condition, size, and maturity. While not all products have official grade standards, common sense techniques can be used to ensure the packing and transportation of only high quality items.

Since most of these products are new to many people, uniform high quality in appearance and taste is essential to increasing importer and consumer willingness to try the products and buy them again. Packing, precooling, refrigerating, transporting, storing, and selling poor quality products wastes time, money, and materials.

Grading Practices

Clean and treat products only as necessary:

- wash off dirt and debris from harvest operations.
- discard bruised, cut, decayed, insect infested, odd sized, immature, or over-ripe items.
- use only officially approved fungicides/bactericides to limit decay on certain products, strictly in accordance with the label instructions.
- use only officially approved wax coatings to reduce moisture loss on certain products, strictly in accordance with the label instructions.
- use only officially approved pesticides or procedures for certain products to eliminate insect pests, strictly in accordance with the label instructions and health and safety regulations.
- remove field heat (precool) as soon as possible after harvest.
- use ethylene gas for certain products to ripen and improve color.

Sort and package produce by size and level of maturity:

- use voluntary grade standards or buyer's specifications.
- place only uniform sizes or amounts in each shipping container.
- place only products with a uniform level of maturity in each container.
- clearly mark the grade, size, weight, or count on the container.

Equipment manufacturers can provide advice on harvesting, washing, sorting, sizing, weighing, waxing, drying, precooling, and packaging equipment suitable for a particular operation. The U.S. Food and Drug Administration (FDA), the Environmental Protection Agency (EPA), and chemical companies can provide the most current information on U.S. regulations for fungicides, bactericides, waxes, and pesticides. Foreign countries that regulate the use of these chemicals also can provide information. APHIS must monitor any necessary quarantine treatments of imported and exported products.

Grade Standards

The USDA Agricultural Marketing Service (AMS) maintains 156 standards covering 85 products as well as inspection instructions. They are listed in Appendix 2. The standards and instructions give guidance on size, color, shape, texture, maturity, cleanliness, and defects. The standards are voluntary except in the case of the products mentioned below.

Under USDA domestic marketing orders only the following items are subject to mandatory grade, size, quality, or maturity regulations:

avocados	kiwifruit	Irish potatoes
dates	limes	prunes
filberts	canned ripe olives	raisins
grapefruit	onions	tomatoes
table grapes	oranges	walnuts

Regulations for imports of the above items must conform to the domestic marketing orders and apply only when the marketing orders are in effect. Shippers and importers must keep abreast of the changing dates and scope of the orders.

Some U.S. State governments and industry trade associations have grade standards or regulations for particular products. Examples are Hawaiian grades for ginger root, papaya, and pineapple; Puerto Rican grades for coconuts; and industry grades for bananas.

Official Inspections

Inspections for grade, condition, size, or maturity may be requested by shippers, receivers, importers, or any other financially interested party. The inspections can be done at the shipping point, receiving market, and in the case of imports, at the port of entry. Regardless of whether the inspection is voluntary or mandatory, licensed federal or federal/state agricultural employees will perform the inspection and issue an official inspection certificate. A fee is charged for these inspections.

All domestic and imported raw or processed fruit and vegetables are subject to inspection by the FDA for illegal pesticide residues or other contamination according to tolerances established by the EPA. These tolerances are called "defect action levels." Products with prohibited or excessive pesticide residues or contamination must be reconditioned, reexported, or destroyed.

All imported fruits, vegetables, plants, cut flowers, and other plant material are subject to inspection by APHIS for harmful insects, diseases, and prohibited items at the U.S. port of entry. APHIS requests 12 hours notice prior to the arrival of the ship, plane, or truck in order to have inspectors on hand. By prior arrangement, APHIS will inspect products in the country of origin under a preclearance program. Fees are charged for this service.

Depending on type of product, insect, or disease, shipments are either released, treated with pesticide and released, destroyed, or reexported. Importers attempting to bring in prohibited items are subject to fines. The U.S. Customs Service assists APHIS in ensuring that agricultural products are properly cleared through the port of entry.

When requested by the receiving country, exports of U.S.-grown fruits, vegetables, plants, or cut flowers are inspected for insects or disease and provided with a phytosanitary certificate by APHIS or U.S. State Departments of Agriculture. AMS provides certifications of grade and quality for fresh products and a verification program for frozen or otherwise processed agricultural products.

Quality control with grading helps growers and shippers to meet the needs of different markets, pass inspections, become reliable suppliers, and receive higher prices for their products. Quality control reduces the risk of financial loss from downgraded or rejected shipments.

Maintain Quality With Effective Packaging

Proper packaging of fruits and vegetables, plants, and cut flowers is essential to maintaining product quality during transportation and marketing. In addition to protection, packaging in the form of shipping containers, serves to enclose the product and provide a means of handling. It makes no sense to ship high quality, high value, perishable products in poor quality packaging which will lead to damage, decay, low prices, or outright rejection of the products by the buyer.

Packaging must withstand:

- rough handling during loading and unloading.
- compression from the overhead weight of other containers.
- impact and vibration during transportation.
- high humidity during precooling, transit, and storage.

Materials

Packaging materials are chosen on the basis of needs of the product, packing method, precooling method, strength, cost, availability, buyer specifications, and freight rates. Importers, buyers, and packaging manufacturers provide valuable recommendations. Materials used include:

- fiberboard bins, boxes (glued, stapled, interlocking), lugs, trays, flats, dividers or partitions, and slipsheets.
- wood bins, crates (wirebound, nailed), baskets, trays, lugs, pallets.
- paper bags, sleeves, wraps, liners, pads, excelsior, and labels.
- plastic bins, boxes, trays, bags (mesh, solid), containers, sleeves, film wraps, liners, dividers, and slipsheets.
- foam boxes, trays, lugs, sleeves, liners, dividers, and pads.

Bins, boxes, crates, trays, lugs, baskets, and bags are considered shipping containers. Baskets, however, are difficult to handle in mixed loads of rectangular boxes. Bags provide limited product protection. The fiberboard box is the most widely used container. Styles include:

- one-piece slotted box with glued, stapled, or self-locking flaps (Fig. 1).
- two-piece half slotted box with a cover (Fig. 2).
- two-piece half slotted box with a full telescoping cover, providing strong walls and corners (Fig. 3).
- three-piece Bliss-style box featuring stapled or glued ends providing strong corners (Fig. 4).
- one-piece box with a full telescoping cover (Fig. 5).
- one-piece box with a tuck-in cover (Fig. 6).
- self-locking tray (Fig. 7).
- interlocking box with wire or fiberboard tabs or hardboard end inserts and plastic end caps, providing stacking strength and alignment. (Fig. 8).

A minimum 1896 kPa (275 lb/in²) bursting test strength fiberboard is recommended for boxes intended for export. The strength is needed for the handlings, transport conditions, and high humidity the boxes must endure.

Fiberboard Box Styles

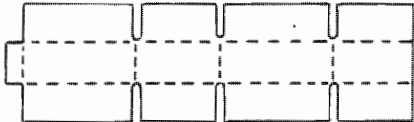
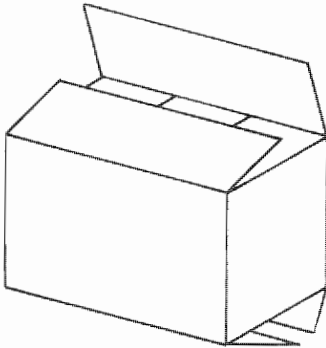

Figure 1. One-piece box.

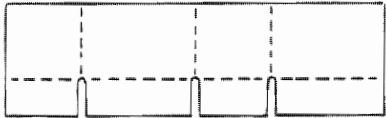
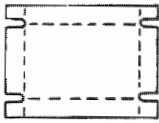
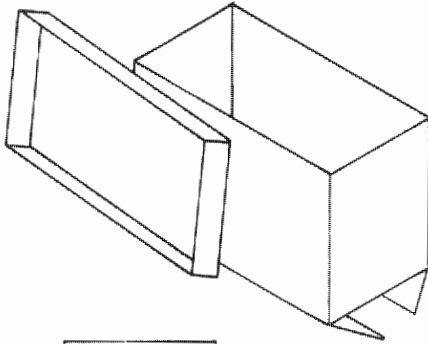

Figure 2. Two-piece box with cover.

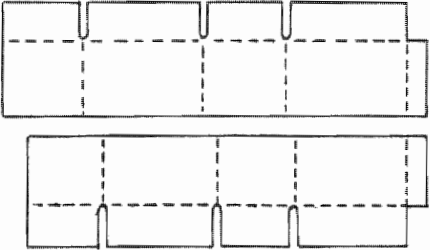
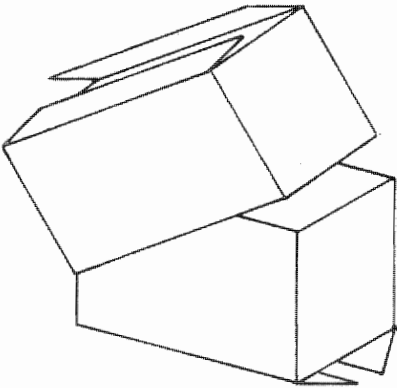

Figure 3. Full telescoping box.

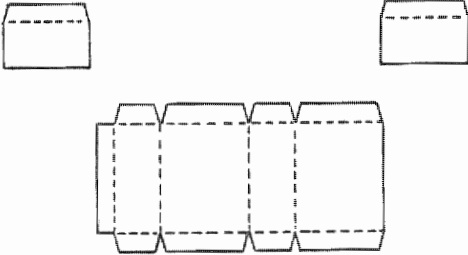
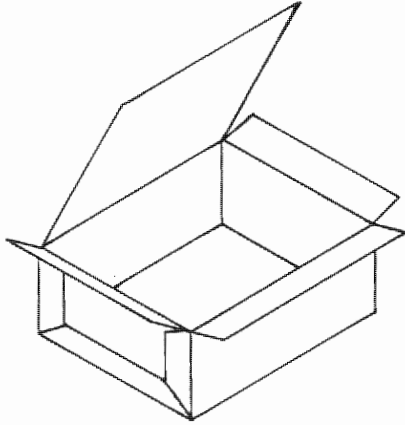

Figure 4. Bliss-style box.

Source: Fibre Box Association (6).

Fiberboard Box Styles

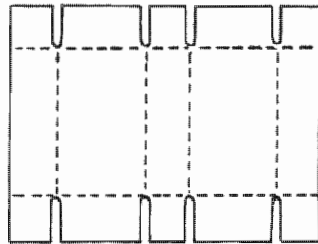
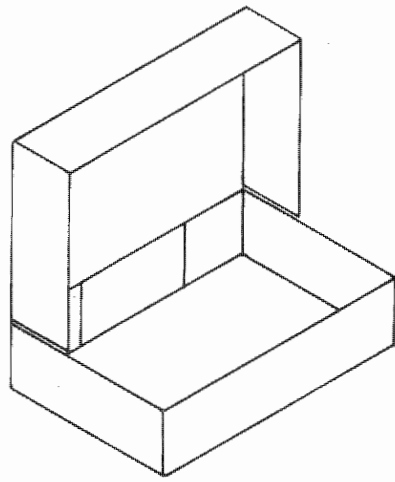

Figure 5. One-piece telescoping box.

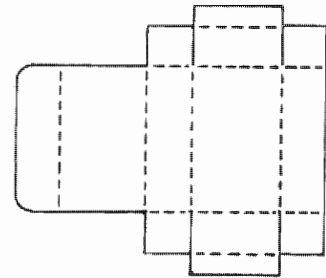
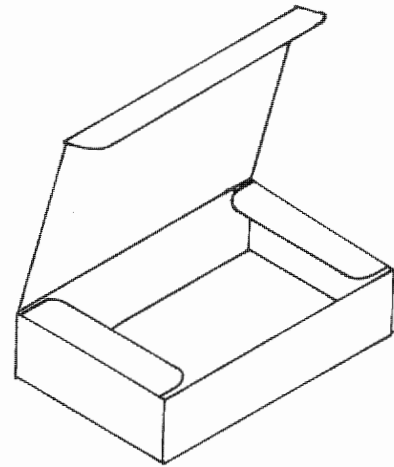

Figure 6. One-piece tuck-in cover box.

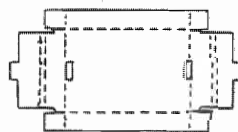
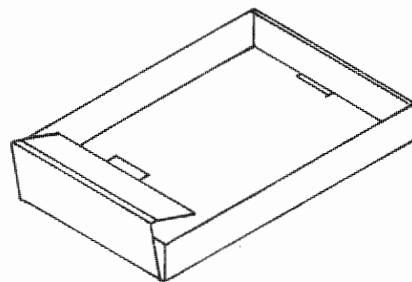

Figure 7. Self-locking tray.

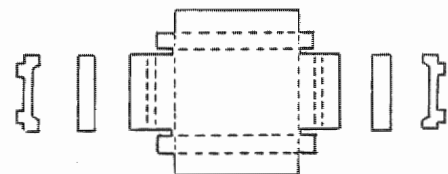
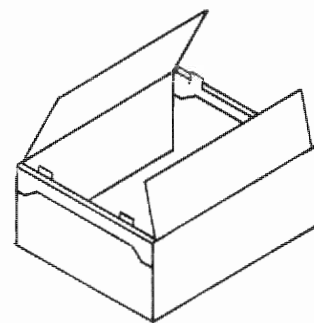

Figure 8. Interlocking box.

Source: Fibre Box Association (6).

Materials

Fiberboard boxes for products which are packed wet or with ice must be wax-impregnated or coated with water resistant material. The compression strength of untreated fiberboard can be reduced more than one half in conditions of 90 percent relative humidity. In addition to maintaining box strength, wax helps to reduce the loss of moisture from the product to the fiberboard. All glued boxes should be made with a water resistant adhesive.

Holes are provided in most fiberboard boxes to provide ventilation of product heat (respiration) and allow circulation of cold air to the product. Handholds provide a means of handling boxes during loading and unloading. All holes must be designed and placed in a manner that does not substantially weaken the box.

Wood crates are still popular with some shippers due to the material strength and resistance to high humidity during precooling, transit, and storage. Wood crates are constructed in a manner that allows a lot of air circulation around the packed product.

The majority of fiberboard boxes and wood crates are designed to be stacked top to bottom. Compression strength and product protection are sacrificed when boxes or crates are stacked on their ends or sides. Misaligned boxes can lose up to 30 percent of their strength, while cross-stacked boxes can lose up to 50 percent of their top to bottom compression strength.

Various materials are added to shipping containers to provide additional strength and product protection. Dividers or partitions and double or triple thickness sides and ends in fiberboard boxes provide additional compression strength and reduce product damage.

Pads, wraps, and sleeves and excelsior also reduce bruising. Pads also are used to provide moisture as with asparagus; provide chemical treatment to reduce decay as with sulfur dioxide pads for grapes; and absorb ethylene as with potassium permanganate pads in boxes of bananas and flowers.

Plastic film liners or bags are used to retain moisture. Perforated plastic is used for most products to allow exchange of gases and avoid excessive humidity. Solid plastic is used to seal the products and provide for a modified atmosphere by reducing the amount of oxygen available for respiration and ripening. This is done for bananas, strawberries, and tomatoes.

Paper and polystyrene foam liners help to insulate the product from hot or cold temperatures when they are shipped in unrefrigerated air cargo holds. Wet newsprint is used to provide moisture to fresh cut herbs and flowers.

Shippers should check with APHIS prior to utilizing packing materials made out of plant parts such as straw or leaves. Some items are prohibited entry into the United States and other countries. Soil also is restricted.

Methods

Packing methods include:

- field packing—products are placed in fiberboard boxes or wood crates during harvesting. Some products are wrapped. The filled containers are then taken to a precooling facility to have the field heat removed.
- shed packing—products are processed or packed indoors or under cover at a central location. The product is brought from the field to the packing shed in bulk in field crates, bins, or trucks. The products are precooled either before or after they are placed in shipping containers.
- repacking—products are taken out of one container, regraded, and placed in another. This is often done to make smaller containers for the retailer or consumer packages.

Types of Packs

Types of packs include:

- volume fill—products are placed by hand or machine into the container until the desired capacity, weight, or count is reached.
- tray or cell pack—products are placed in molded trays or cells which provide separation and reduced bruising.
- place pack—products are wrapped and carefully placed in the container. This provides reduced bruising and a pleasing appearance.
- consumer pack or prepack—relatively small amounts of product are packaged, weighed, and labeled for retail sale.
- film or shrink wrap—each fruit or vegetable is individually wrapped and sealed in film to reduce moisture loss and decay. The film may be treated with fungicides or other chemicals.
- modified atmosphere—individual consumer packs, shipping containers, or pallet loads of containers are sealed with plastic film or bags. The oxygen level is reduced and the carbon dioxide level is increased. This reduces product respiration and slows the ripening process.

Shipping containers must be sized and filled correctly. Containers which are very wide and weigh more than 23 kg (50 lb) encourage rougher handling, product damage, and container failure. Overfilling causes product bruising and excessive bulging of the sides of the container, which leads to decreased compression strength and container failure. Underfilling also causes product damage. The product is bruised as it moves around inside the shipping container during transport and handling.

What Packaging Must Withstand

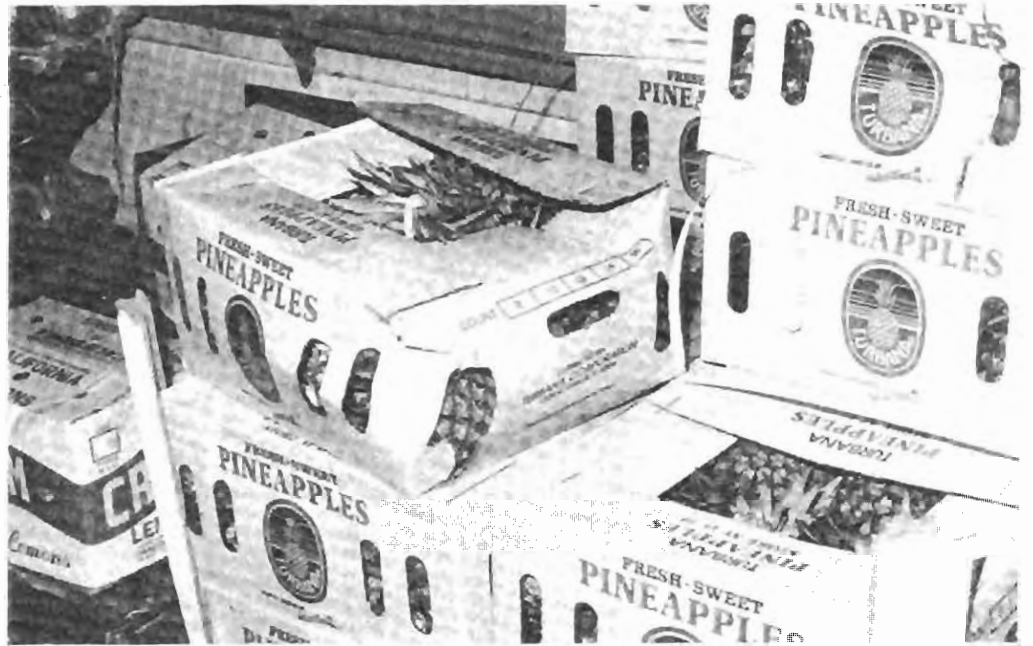

Rough handling. The pineapple box was dropped during unloading. The ventilation holes are much too large and too close to the corners. Circular holes, strategically placed, would provide adequate ventilation without reducing the strength of the box.



Compression. These melon boxes do not have sufficient strength to withstand multiple handling and the overhead weight of the other containers.

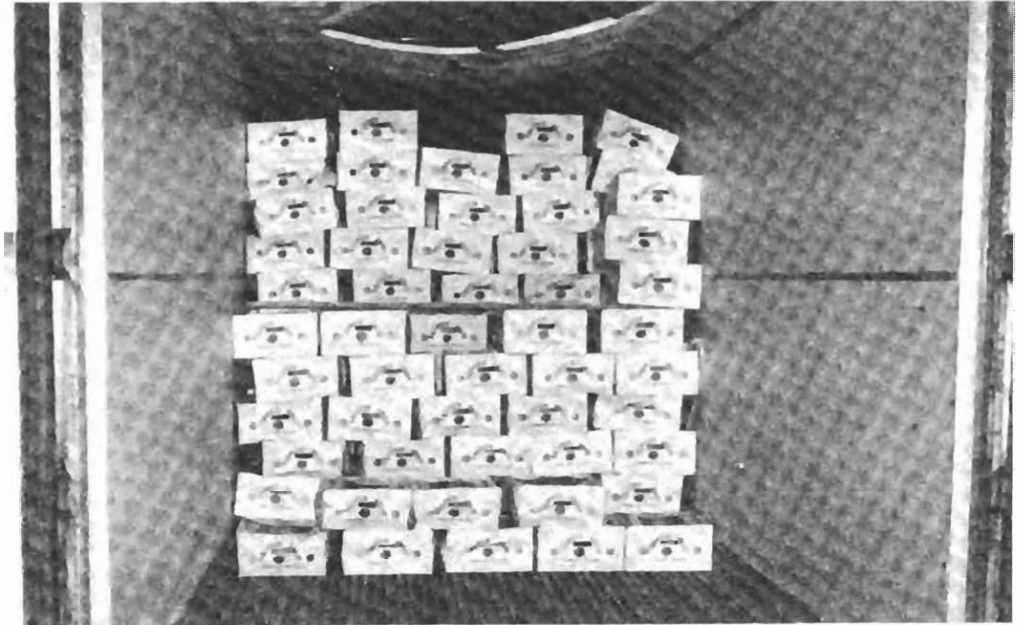

Impact and vibration. These melon boxes shifted during transportation. The boxes do not have sufficient compression strength for stacking in the offset pattern used to provide air circulation between the layers of boxes.



High humidity. Packaging must allow for moisture including top-icing or package-icing when recommended for the product. These waxed fiberboard boxes of green onions are meant to be iced.

Types of Packs



Field packing of celery in one-piece fiberboard boxes. The ventilated boxes are then palletized and taken from the field to a vacuum cooling facility.



Shed packing of mushrooms in self-locking fiberboard trays. The mushrooms have been prepacked in fiberboard containers, film wrapped, and labeled for retail sale.

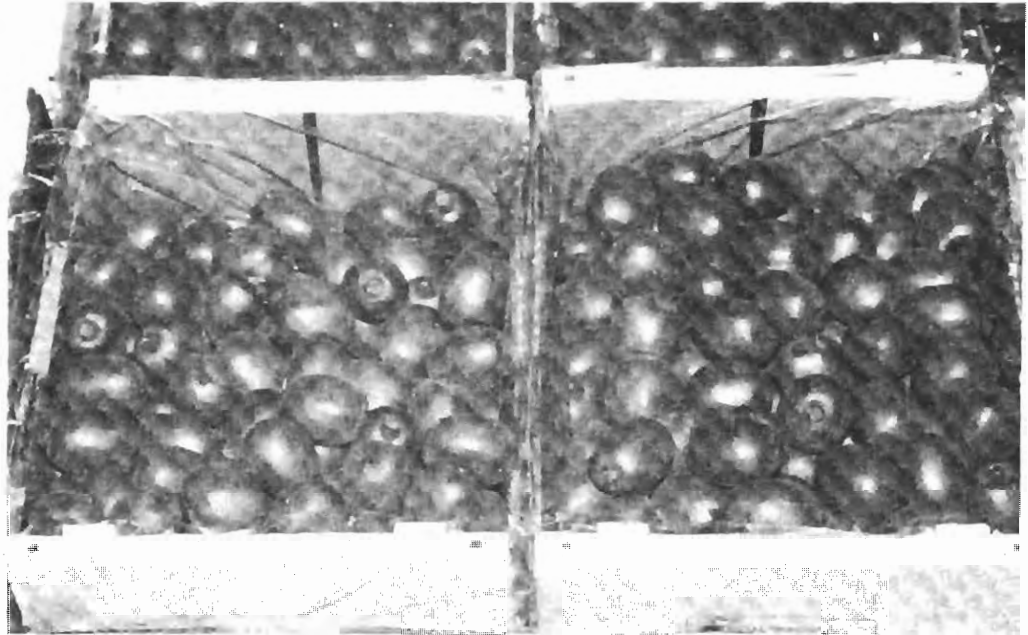

Volume-filled interlocking boxes of kiwifruit. The plastic end tabs provide compression strength and interlock the film lined boxes when they are stacked on pallets.

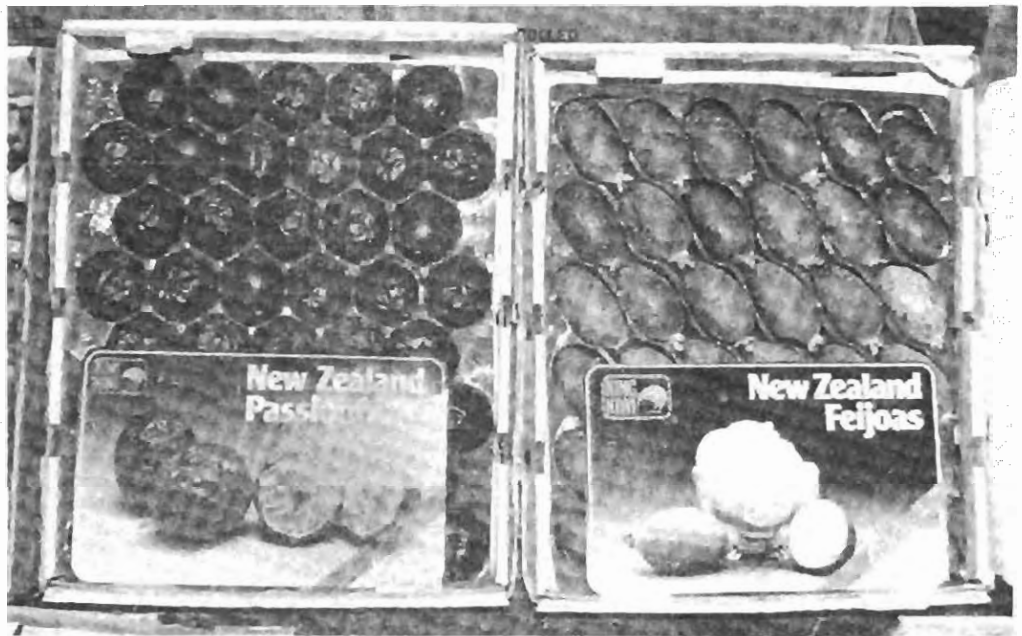

Cell-packed passionfruit and feijoas in plastic trays inside fiberboard trays. Posters are provided by the shipper for display in the food store.

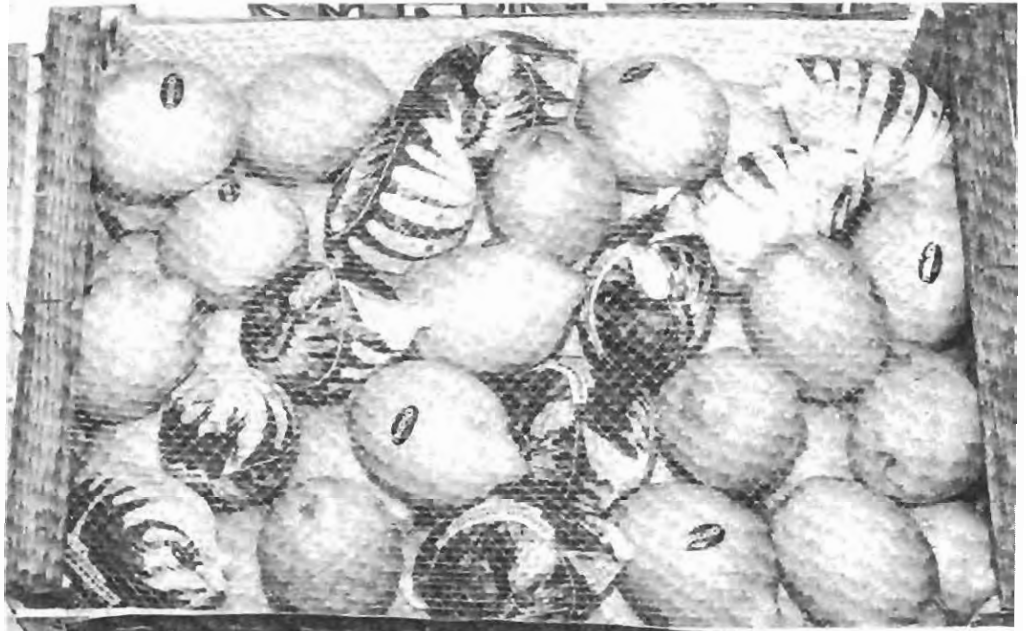

Place-packed brand-named lemons in a nailed wood crate with colorful tissue paper wrappers, labels, and plastic netting enclosing the contents.



Place pack of cactus pears in a full telescoping waxed fiber-board box. Each fruit is wrapped in labeled tissue paper which includes handling and recipe information for the consumer.



Consumer pack of brussels sprouts in a fiberboard tray of one dozen film wrapped 284 g (10 oz) fiberboard baskets labeled for retail sale.

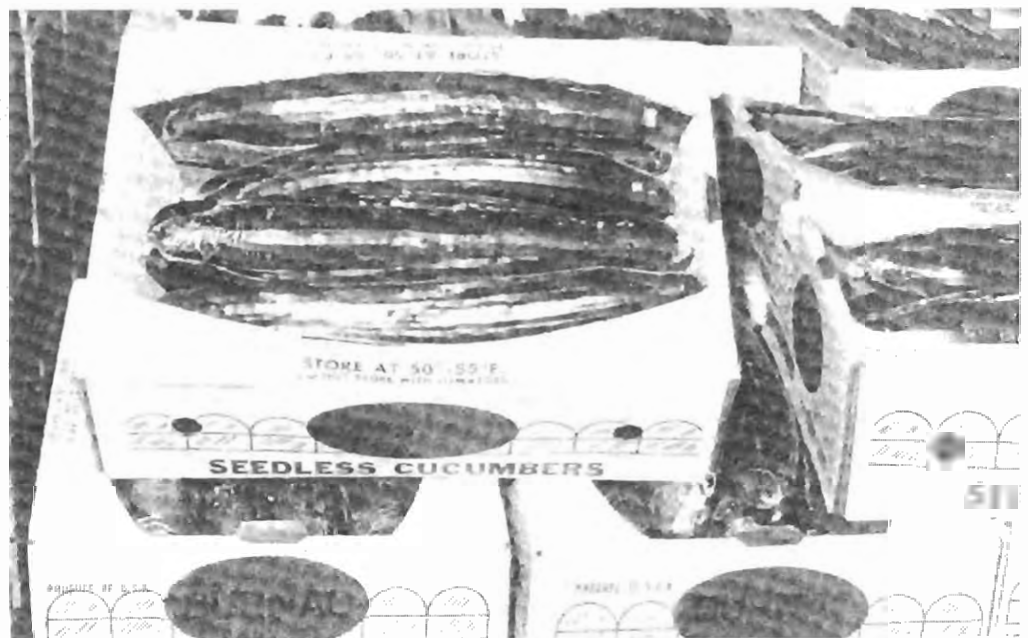

Shrink-wrapped seedless cucumbers in a self-locking fiberboard tray. Storage instructions are printed on the box.

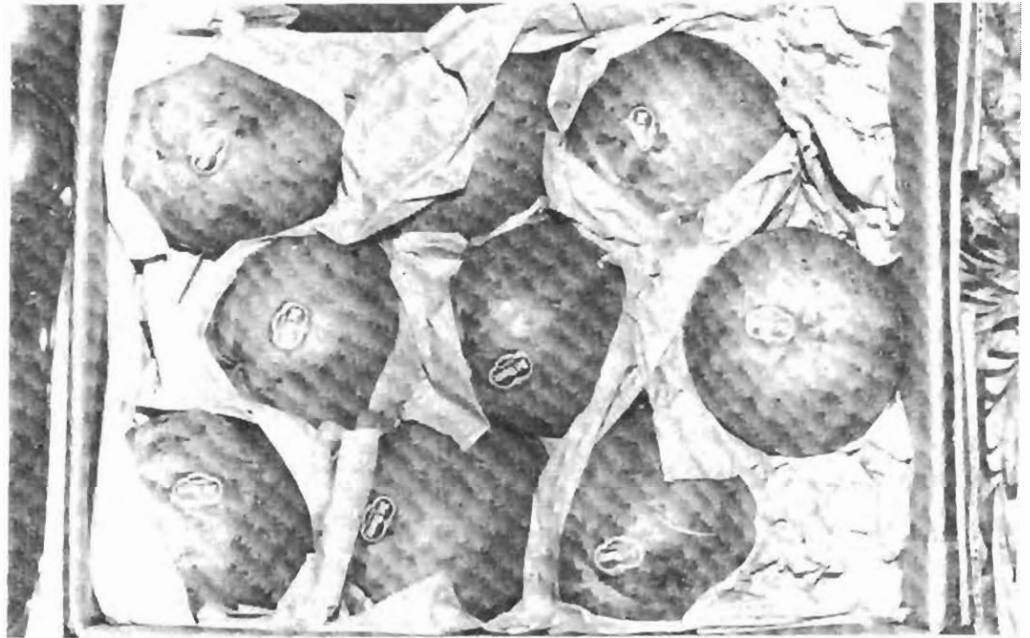

One-piece fiberboard box of papaya protected with paper padding and labeled with brand name stickers. The papaya are packed by count and placed in a single layer.

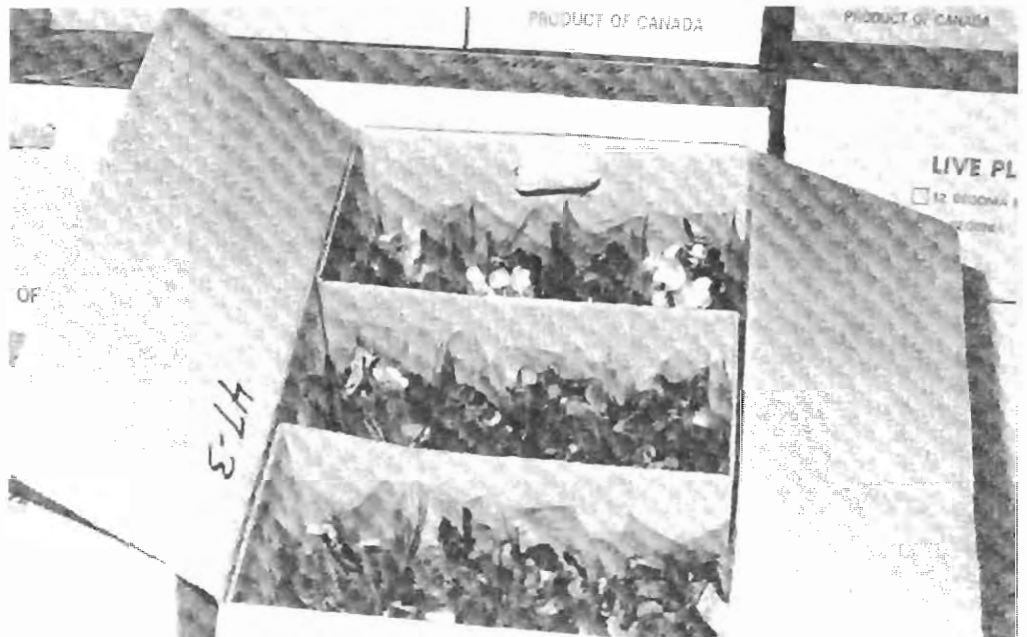

One-piece fiberboard box of potted begonia plants protected with plastic sleeves and a fiberboard divider.



Two-piece fiberboard box of limes with cover, volume-filled to 4.5 kg (10 lb).



Full telescoping fiberboard boxes of garlic volume-filled to 13.6 kg (30 lb).

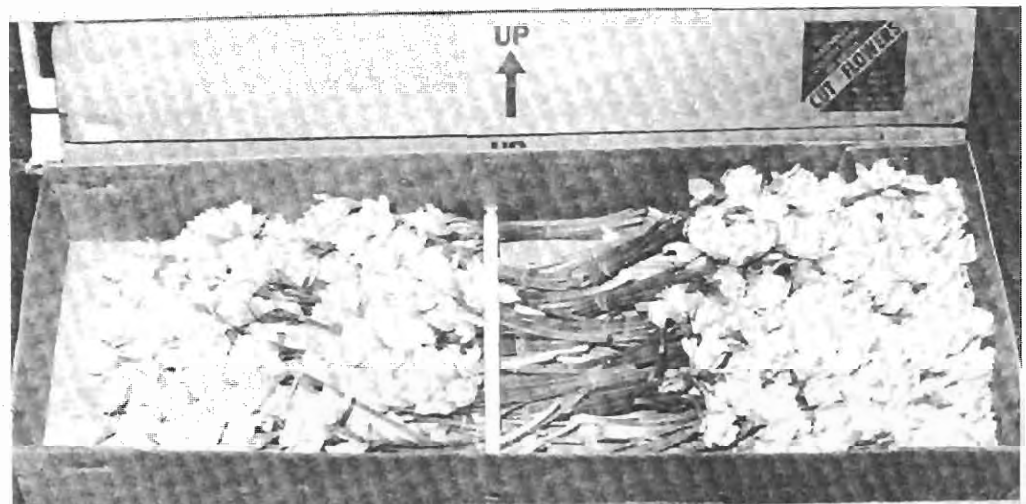

FLOWERS RUSH-PERISHABLE
KEEP IN A COOL PLACE, AVOID EXCESSIVE HEAT OR MOISTURE

Full telescoping box of bunched daffodils held in place with a wood cleat attached to the sides of the box.

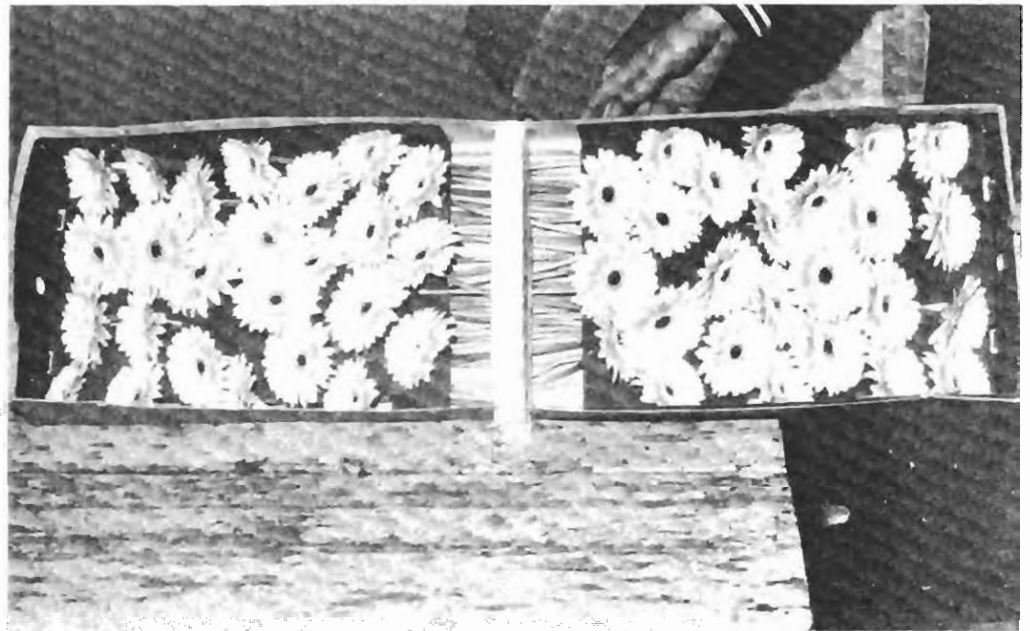

Full telescoping box of gerbera daisies. Each flower stem is threaded through a hole in a fiberboard holder which is then stapled to the sides of the box. The stems are secured by a poly-styrene foam cleat which also provides compression strength for the box when stacked.



Full telescoping wax impregnated fiberboard boxes of asparagus packed vertically, with openings to allow ventilation of heat from product respiration. A moistened pad is provided at the bottom of the box.

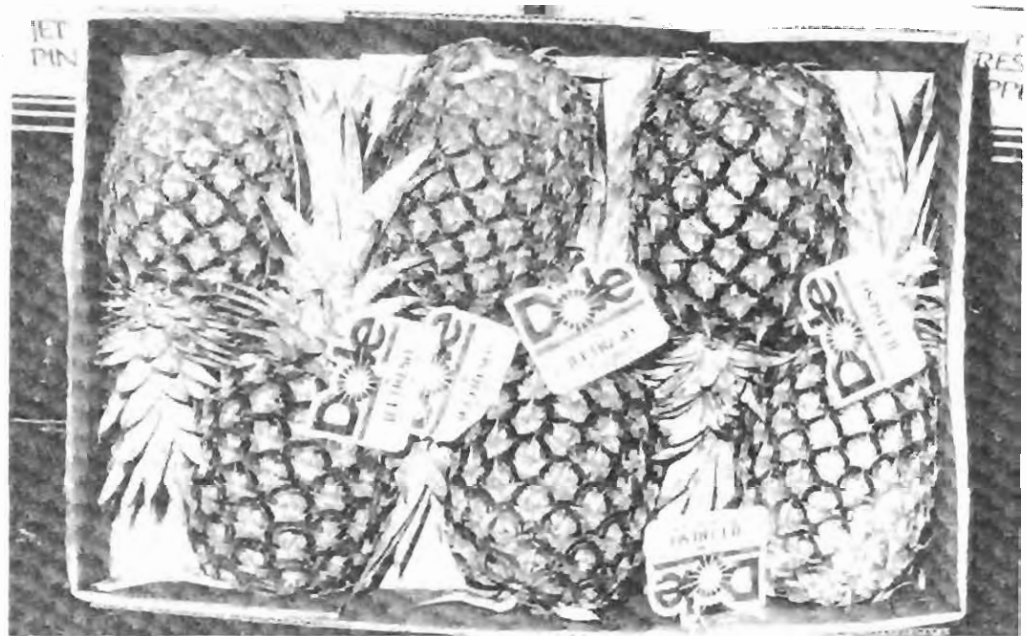

Full telescoping box of pineapple, packed flat to avoid compression damage to the top of the fruit. Each pineapple has a colorful brand name label.

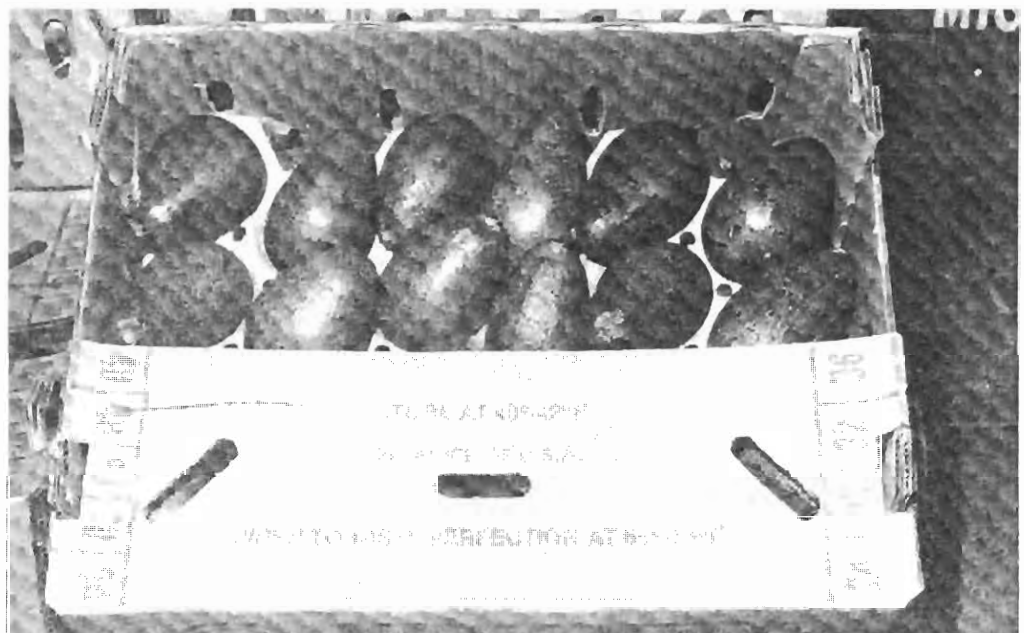

Bliss-style fiberboard box of tray packed avocados. Vertical fiberboard tabs interlock the boxes when they are stacked on pallets. The 2 layers of avocados are placed on molded fiberboard trays. Product count and storage instructions are printed on the box.

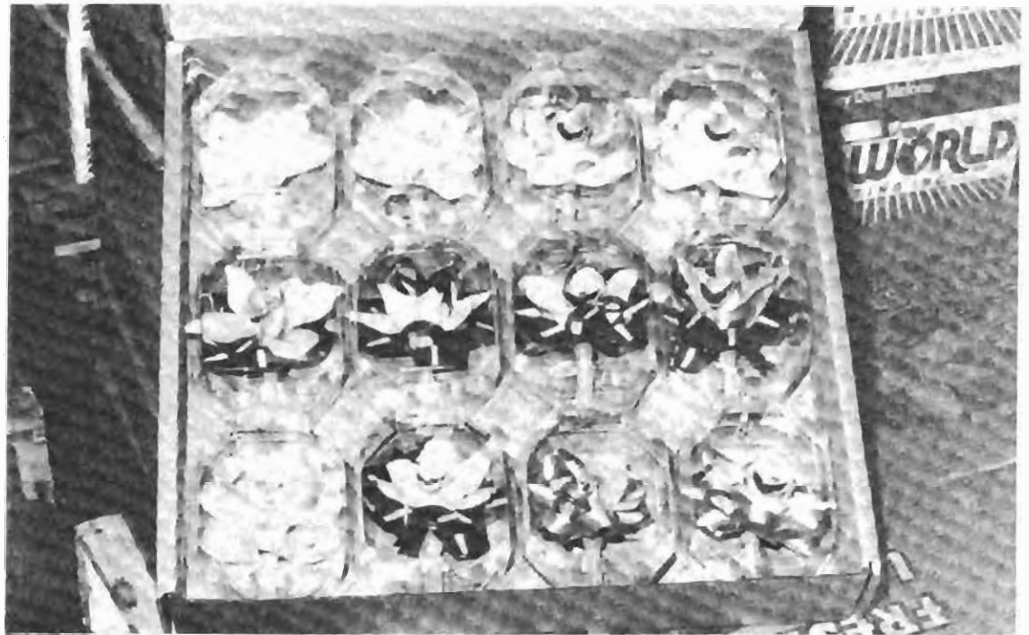

One-piece box with tuck-in cover of cybidium orchids in vials of floral preservative solution. Each orchid is encased in a plastic container. Colorful ribbons supply additional support for the flowers.



Self-locking fiberboard tray of tomatoes which are protected from bruising by polystyrene foam sheet dividers.



Self-locking fiberboard tray of consumer packed raspberries in 227 ml (1/2 pt) plastic wrapped containers.



A fiberboard divider adds compression strength to this full telescoping box of honeydew melons with interlocking top flaps.

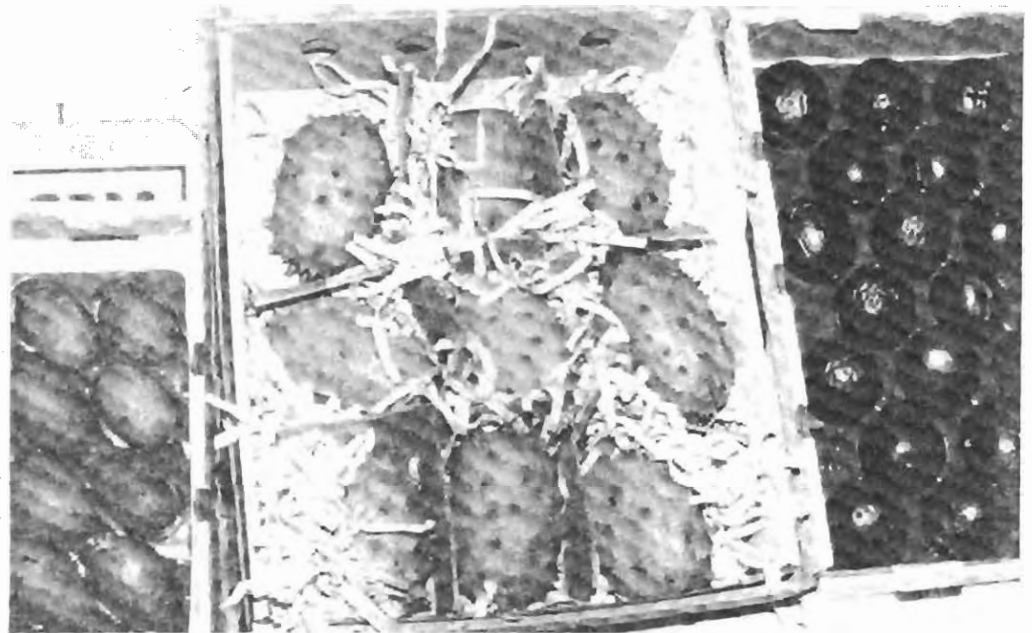

Fiberboard dividers and shredded paper provide protection from bruising to the horned melons (kiwanos) in this full telescoping fiberboard box.

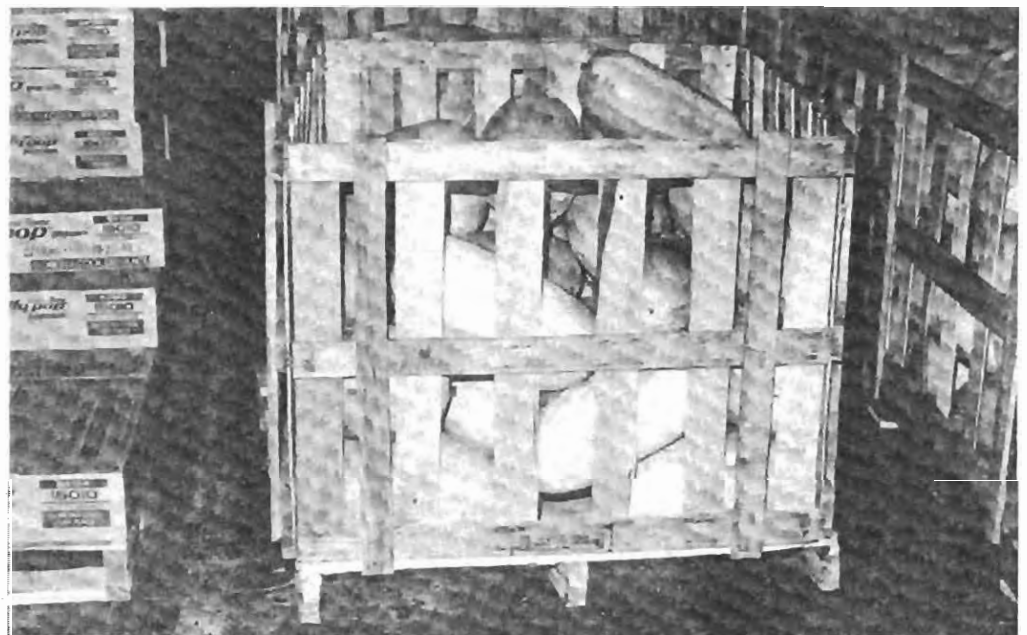

Collapsible wood bins of watermelons with pallet bases provide easier handling with less damage. Fiberboard as well as wood bins also can be used to handle bagged products such as cabbage, calabaza, carrots, and onions.



Wirebound wood crate of tangerines. Wirebound crates also are used for many vegetables including beans, eggplant, greens, melons, peppers, and squash.

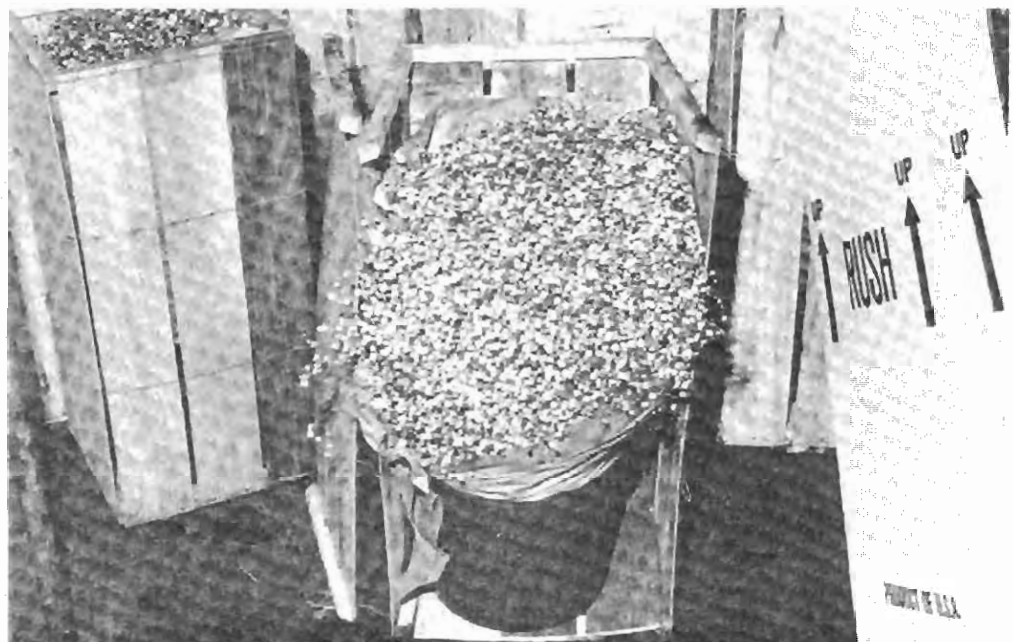

Wirebound wood crate of gypsophila. The flowers are packed wet in a plastic container of floral preservative solution. A paper sleeve protects the flowers from the sides of the crate during handling and transportation.

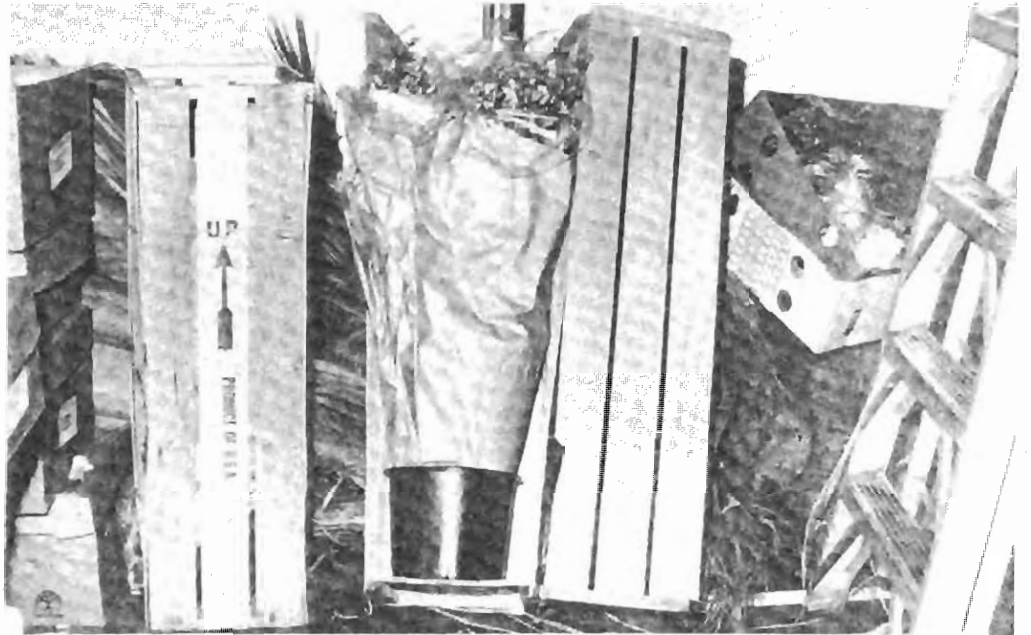

Wirebound wood crate of bunched lilies packed wet in a plastic container. Each bunch is individually protected with plastic sleeves.



Nailed wood pyramid crates of asparagus. The crates provide compression strength and ventilation. A moistened pad is placed at the bottom of the asparagus stalks to maintain quality.



Nailed wood crates of garlic with wire banding provide additional room for ventilation due to their shape.



Plastic film bags of topped carrots. Small holes in the bag allow exchange of gases while still maintaining a high humidity.

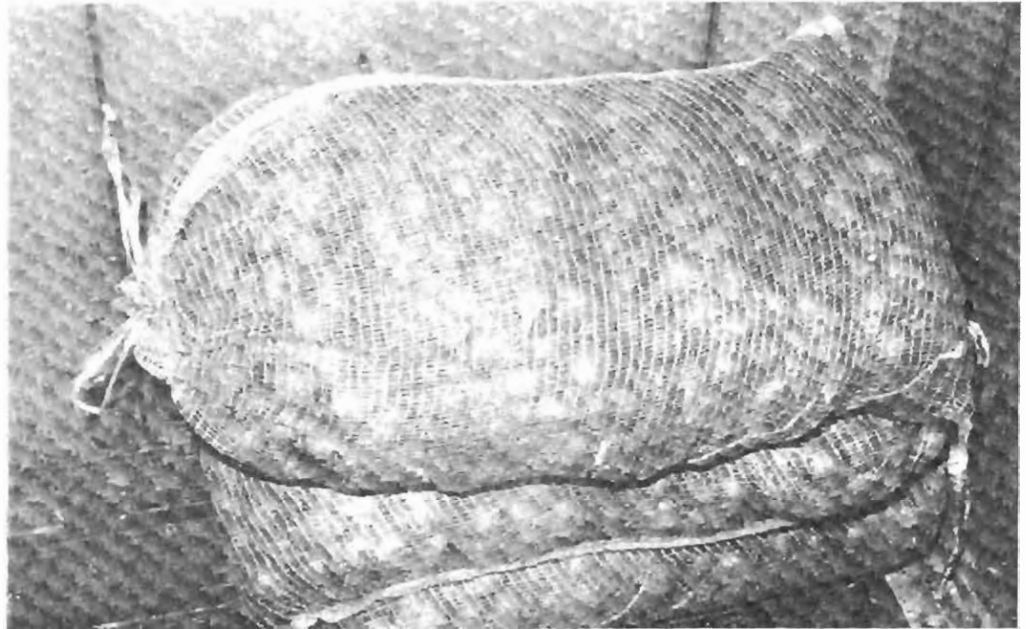

Plastic mesh bags of shallots. The mesh provides the necessary ventilation for this product which is damaged by moisture and high humidity.



Plastic containers of hydroponic lettuce. The containers which provide protection and a high level of humidity and are labeled with consumer information.



Plastic sleeves protect these potted begonia plants from handling damage. Paper and polyester sleeves also are used for potted plants.

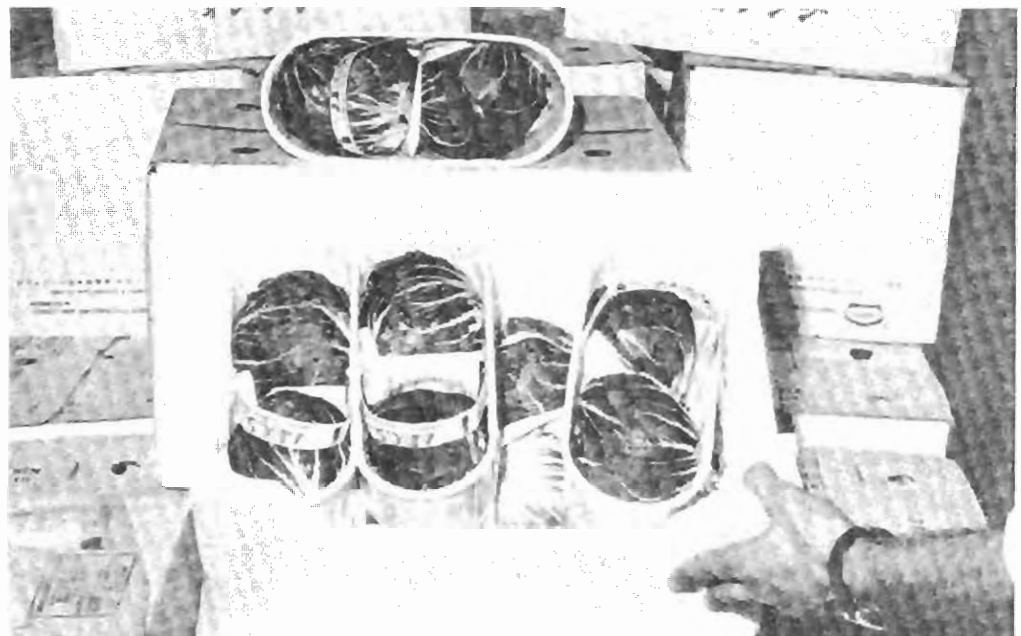

Polystyrene foam box of raddichio with a perforated plastic cover. The raddichio is consumer packed in plastic containers with consumer handling information and recipes.

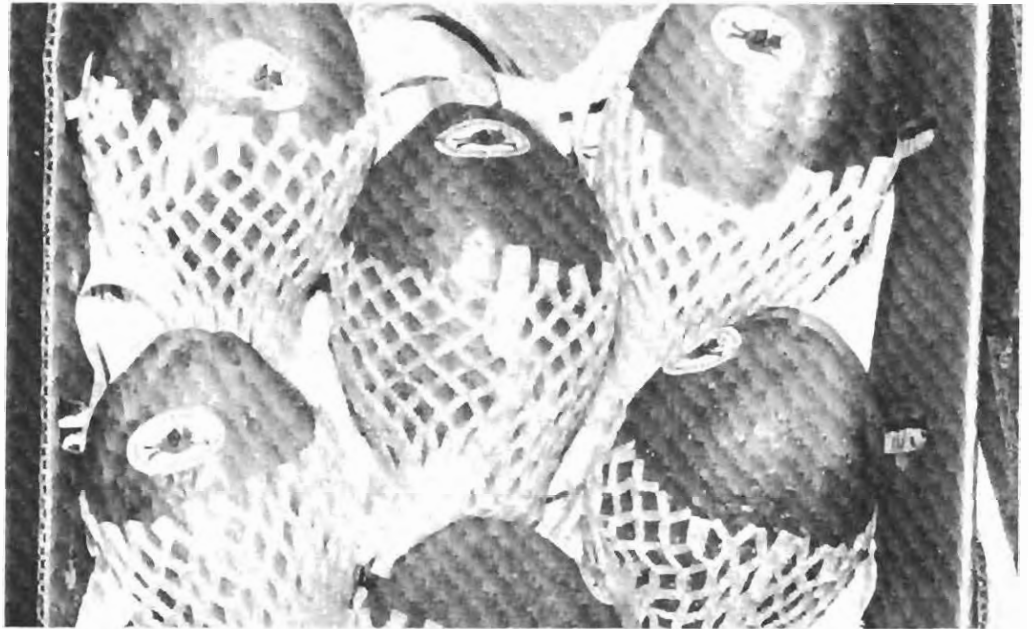

Foam mesh sleeves and shredded paper protect these papaya from bruising. Each fruit is labeled with a brand name sticker.

Standardization

Due to large number of different container sizes in use, box standards have been developed by the fruit and vegetable and floral industries.

Standardized containers:

- reduce container inventory for manufacturers and growers.
- utilize, with other containers, 90 to 100 percent of the surface of the widely used 1219 x 1016 mm (48 x 40 in) standard pallet, with no overhang and little underhang.
- provide unit loads and more stable mixed pallet loads.
- reduce transportation and marketing costs.

Project MUM was developed by the fruit and vegetable industry and the USDA to encourage container standardization and unit loads. The acronym stands for Modularization, Unitization, and Mechanization. Table 1 shows 11 recommended MUM containers arranged on a standard pallet and Table 2 lists current produce shipping containers and their proposed MUM replacements.

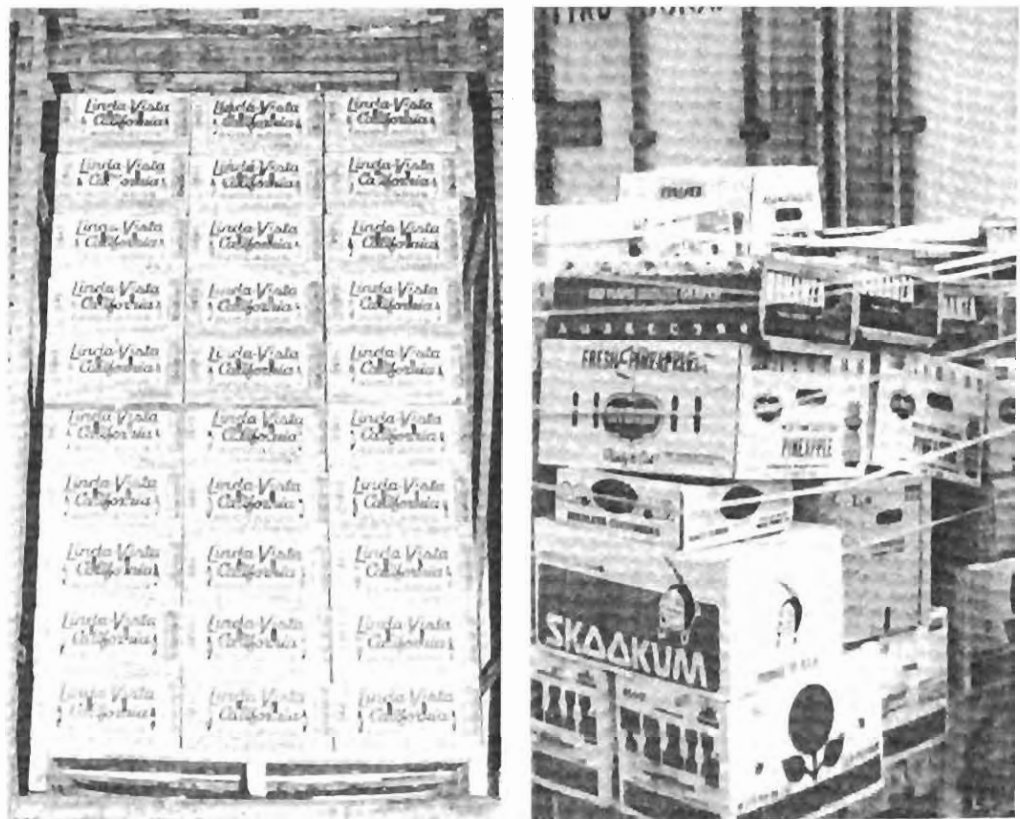

Standardized shipping containers provide stable unit loads as shown on the left and will help reduce unstable mixed loads as shown on the right.

Table 1. Recommended MUM container sizes, listed by outside length and width, arranged on a standard pallet, 1219 x 1016 mm (48 x 40 in).

Outside dimensions:
600 x 500 mm
(23.62 x 19.68 in)
Pallet utilization: 100%



Outside dimensions:
500 x 400 mm
(19.68 x 15.75 in)
Pallet utilization: 100%

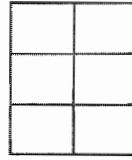

Outside dimensions:
600 x 400 mm
(23.62 x 15.75 in)
Pallet utilization: 100%

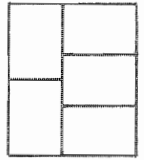

Outside dimensions:
500 x 333 mm
(19.68 x 13.11 in)
Pallet utilization: 97%

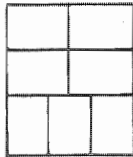

Outside dimensions:
600 x 333 mm
(23.62 x 13.11 in)
Pallet utilization: 99%



Outside dimensions:
500 x 300 mm
(19.68 x 11.81 in)
Pallet utilization: 100%

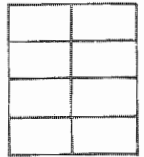

Outside dimensions:
475 x 250 mm
(18.70 x 9.84 in)
Pallet utilization: 99%

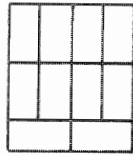

Outside dimensions:
400 x 300 mm
(15.75 x 11.81 in)
Pallet utilization: 100%

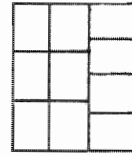

Outside dimensions:
433 x 333 mm
(17.01 x 13.11 in)
435 x 330 mm
(17.12 x 12.99 in)
Pallet utilization: 96%

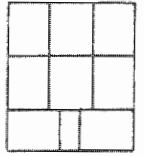

Outside dimensions:
400 x 250 mm
(15.75 x 9.84 in)
Pallet utilization: 100%

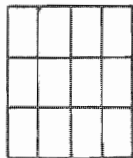

Outside dimensions:
400 x 333 mm
(15.75 x 13.11 in)
Pallet utilization: 99%

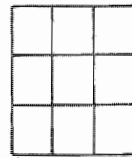

Table 2. Current produce shipping containers and their proposed MUM replacement.

Produce item	A current commercial container			MUM replacement	
	Outside dimension of a current standard container <u>mm (in)</u>	Measured gross weight or count	Capacity printed on container	Outside <u>cm</u>	Measured gross weight or count
Avocados (Haas)	440 × 355 × 184 (17.32 × 13.97 × 7.24)	48 count	—	50 × 30 × 18	50 count
Beans (green)	392 × 304 × 304 (15.43 × 11.97 × 11.97)	28.5 lb	1 bu	40 × 30 × 30 50 × 30 × 25	31.5 lb 28.0 lb
Broccoli	508 × 300 × 272 (19.9 × 11.81 × 10.7)	14 bunches	—	50 × 30 × 30	14 bunches
Cabbage (green)	600 × 425 × 285 (23.62 × 16.73 × 11.22)	17 head	—	60 × 40 × 30	18 head
Cabbage (green (approx. 7" diameter))	585 × 360 × 340 (23.03 × 14.17 × 13.38)	14 head	1-3/4 bu	60 × 40 × 30	14 head
Cabbage (red)	641 × 335 × 340 (25.23 × 13.18 × 13.38)	16 head	—	50 × 40 × 30	16 head
Celery (Michigan 3")	515 × 380 × 290 (20.27 × 14.96 × 11.41)	35 count	—	50 × 40 × 30	38 count
Cucumbers (Super Select)	454 × 308 × 305 (17.87 × 12.12 × 12.00)	85 count	1-1/9	50 × 30 × 30	85 count
Eggplant	460 × 315 × 305 (18.11 × 12.40 × 12.00)	19 count	1-1/9 bu	50 × 30 × 30	21 count
Eggplant	365 × 285 × 215 (14.37 × 11.22 × 8.46)	—	5/9 bu	40 × 30 × 20	
Grapefruit (27)	444 × 305 × 273 (CA) (17.48 × 12.00 × 10.74)	27 count	4/5 bu	50 × 30 × 30	32 count
" "	455 × 298 × 261 (FL) (17.91 × 11.73 × 10.27)				
Grapefruit (36)	444 × 305 × 273	36 count	4/5 bu	50 × 30 × 30	40 count
" "	455 × 298 × 261				
Grapefruit (40)	444 × 305 × 273	40 count	4/5 bu	50 × 30 × 30	38 count
" "	455 × 298 × 261				
Grapefruit (48)	444 × 305 × 273	48 count	4/5 bu	50 × 30 × 30	53 count
" "	455 × 298 × 261				
Grapes	415 × 360 × 150	23 lb	23.5 lb	50 × 40 × 11 50 × 30 × 14	24.0 lb 22.0 lb
Greens (spinach, turnip, kale, collard)	515 × 320 × 330 (20.27 × 12.59 × 12.99)	25.5 lb	1-1/4 bu	50 × 40 × 30	25.6 lb
Lemons (115 & 119)	450 × 300 × 260 (17.71 × 11.81 × 10.23)	115 & 119	4/5 bu	40 × 30 × 30	132 count
Lemons (165 & 172)	430 × 300 × 280 (16.92 × 11.81 × 11.02)	165 & 172	4/5 bu	40 × 30 × 30	185 count

Source: Turczyn and Anthony (29).

Table 2. Current produce shipping containers and their proposed MUM replacement—Continued.

Produce item	A current commercial container			MUM replacement	
	Outside dimension of a current standard container mm (in)	Measured gross weight or count	Capacity printed on container	Outside cm	Measured gross weight or count
Lettuce (4-5")	550 x 415 x 285 (21.65 x 16.33 x 11.22)	24 head	—	60 x 40 x 30 50 x 40 x 30	40 head 32 head
" (4-1/2-5-1/2")	550 x 415 x 285	24 head	—	60 x 40 x 30 50 x 30 x 30	30 head 24 head
" (5-1/2-6-1/2")	550 x 410 x 285	24 head	—	50 x 40 x 30	18 head
Melons (Honeydew) 7-3/4 in	460 x 410 x 210 (18.11 x 16.14 x 8.26)	5 count	—	50 x 40 x 21	5 count
Okra	484 x 230 x 164 (19.05 x 9.05 x 6.45)		0.436 bu. (1/2)	40 x 30 x 15	1/2 bu
Oranges (88)	455 x 298 x 261 (FL) (17.91 x 11.73 x 10.27)	88 count	4/5 bu	50 x 30 x 30 ± 10	90 count
" "	444 x 305 x 273 (CA) (17.48 x 12.00 x 10.74)				
Oranges (100)	455 x 298 x 261 444 x 305 x 273	100 count	4/5 bu	50 x 30 x 30 ± 10	98 count
Oranges (113)	455 x 298 x 261	113 count	4/5 bu	50 x 30 x 30 ± 10	110 count
" "	444 x 305 x 273				
Peaches (south, 2-1/4")	450 x 290 x 300 (17.71 x 11.41 x 11.81)	41.7 lb	—	50 x 30 x 30	45.8 lb
Peaches (western)					
" (2-1/4")	445 x 356 x (146 - 171) (17.51 x 14.01 x (5.75 - 6.75))	—	25 lb	50 x 30 x 16	26.0 lb
" (2-3/8")	445 x 356 x (146 - 171)	—	25 lb	50 x 30 x 16	23.5 lb
" (2-7/16")	445 x 356 x (146 - 171)		25 lb	50 x 30 x 16	25.9 lb
" (2-5/8")	445 x 356 x (146 - 171)		25 lb	50 x 30 x 16	24.0 lb
" (2-13/16")	445 x 356 x (146 - 171)		25 lb	50 x 30 x 16	24.5 lb
" (2-7/8")	445 x 356 x (146 - 171)		25 lb	50 x 30 x 16	24.5 lb
Pears (110)	457 x 310 x 234 (17.99 x 12.20 x 9.21)	39.5 lb	—	40 x 30 x 30	44.8 lb

Source: Turczyn and Anthony (29).

Table 2. Current produce shipping containers and their proposed MUM replacement—Continued.

Produce item	A current commercial container			MUM replacement	
	Outside dimension of a current standard container <u>mm (in)</u>	Measured gross weight or count	Capacity printed on container	Outside <u>cm</u>	Measured gross weight or count
Peppers (Cuban)	460 x 315 x 305 (18.11 x 12.40 x 12.00)	28.3 lb	1-1/9 bu	50 x 30 x 30	25.8 lb
Peppers (green)	452 x 312 x 305 (17.79 x 12.28 x 12.00)	75 count	1-1/9 bu	50 x 30 x 30	75 count
Peppers (hot)	405 x 305 x 301 (15.94 x 12.00 x 11.85)	—	1 bu	40 x 30 x 30	1 bu
Peppers (red)	480 x 306 x 319 (18.89 x 12.04 x 12.55)	—	1-1/9 bu	50 x 30 x 30	1-1/9 bu
Potatoes (white #1's) (round reds)	495 x 325 x 240 (19.48 x 12.79 x 9.44)	53.3 lb	50 lb	50 x 30 x 30	57.2 Jumble 45.0 lb-9/5 lb bags
Romaine	450 x 305 x 305 (17.71 x 12.00 x 12.00)	17 head	1-1/9 bu	50 x 30 x 30	18 head
Squash (Acorn)	460 x 315 x 305 (18.11 x 12.40 x 12.00)	36 count	1-1/9 bu	50 x 30 x 30	33 count
Squash (Butternut)	460 x 315 x 305 (18.11 x 12.40 x 12.00)	23 count	1-1/9 bu	50 x 30 x 30	24 count
Tomatoes	470 x 300 x 240 (18.50 x 11.81 x 9.44)	—	30 lb	50 x 30 x 23	29.5 lb
Zucchini	480 x 303 x 316 (18.89 x 11.92 x 12.44)	—	1-1/9 bu	50 x 30 x 30	1-1/9 bu

Source: Turczyn and Anthony (29).

Unit Loads

A large number of shippers and receivers have switched from handling individual shipping containers to unit loads on pallets. Most distribution centers are set up to store palletized loads in three tier racks.

Unit loads provide for:

- reduced handling of individual shipping containers.
- less damage to the containers and the products inside.
- faster loading and unloading of transportation equipment.
- more efficient distribution center operations.
- reduced pilferage of products.

Unit loads may include some of the following features:

- standard wood pallets or slipsheets, 1219 x 1016 mm (48 x 40 in).
- fiberboard, plastic or wire vertical interlocking tabs between boxes.
- boxes with holes for air circulation, which align when the boxes are stacked squarely on top of one another, corner to corner.
- glue between boxes to resist horizontal slipping.
- plastic netting around the pallet load of boxes.
- fiberboard, plastic, or metal cornerboards.
- plastic or metal strapping around the cornerboards and boxes.

Pallets

Wood pallets must be strong enough to allow storage under load in three tier racks. Provisions for forklift and pallet jack handling are necessary. The design of the bottom of the pallet should not block air circulation.

Pallets must have an adequate number of top deck boards to support fiberboard boxes. Otherwise the boxes may collapse between deck boards from the overhead weight of the other containers, crush the products, and cause the entire load to lean or fall off the pallet. A sheet of fiberboard with holes for air circulation can be used to distribute weight across the pallet.

Boxes must not overhang the edges of the pallets. Overhang can reduce the strength of fiberboard boxes by one-third. This condition also can lead to collapse of the entire load, crushing of the product, and make loading, unloading, and storage in racks difficult. On the other hand, boxes which utilize less than 90 percent of the pallet surface and do not align with the pallet edge can shift in transit.

Pallet loads of shipping containers which are not strapped or netted should have at least the top three layers of containers cross-stacked to provide stability. Some shippers use film wrap, tape, or glue on the top layers in addition to cross-stacking. The containers must be strong enough to be cross-stacked without collapsing. Film wrap should not be used on shipping containers of products that need ventilation.



Clear plastic netting wrapped around the pallet load of full telescoping fiberboard boxes of pineapples provides for a stable unit load which can be quickly placed in the storage rack.

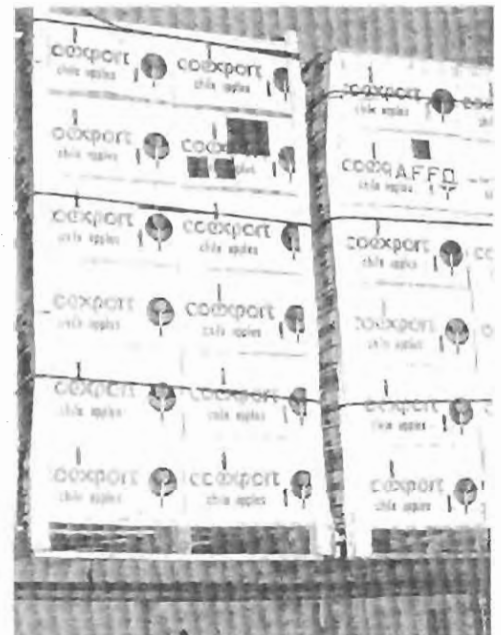

Cornerboards and plastic strapping provide for secure unit loads of apples which are loaded on and off general cargo ocean vessels, transported by highway trailers and placed into storage racks.



Clear plastic netting helps to stabilize this load of honeydew melons. The boxes are too weak and are not stacked carefully on top of one another. Corners of boxes must align to obtain the maximum box strength.

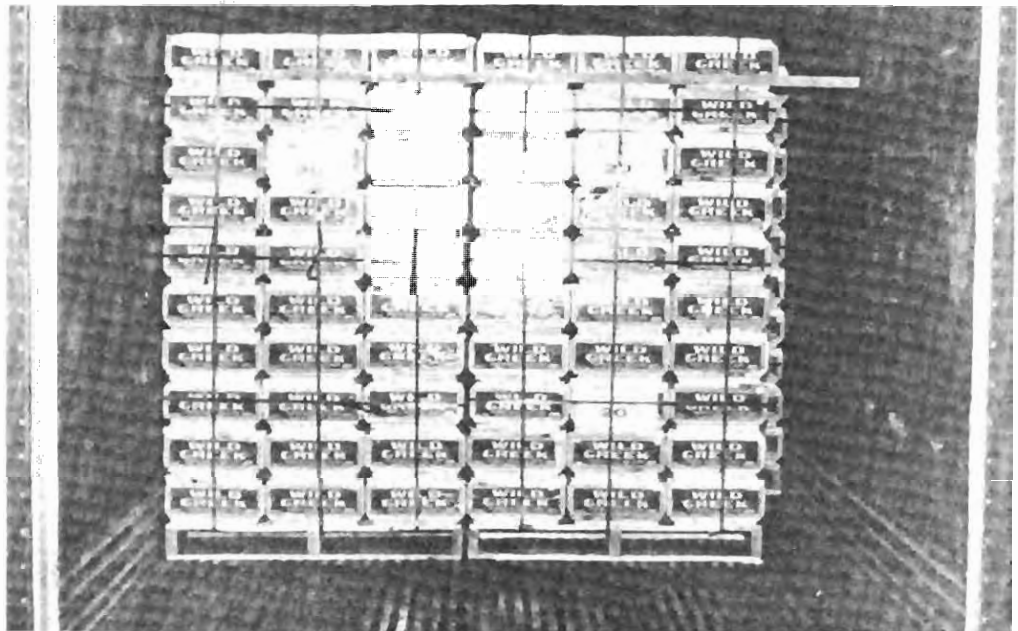

Plastic strapping and top cornerboards are used to unitize this load of grapes packed in wood lugs. A wood strip is nailed across the top of the two pallet loads to brace it against the trailer wall.



Fiberboard locks between the vertical tabs of each interlocking box of table grapes helps to unitize each layer of boxes horizontally. The plastic end tabs on the boxes unitize the boxes vertically, providing stacking strength and alignment.



A fiberboard sheet with slots and holes for ventilation locks together the vertical fiberboard tabs in the top layer of the load of raspberries.



Pallet overhang caused the failure of this pineapple box and damage to the product inside. Boxes lose their compression strength when they are loaded in this manner.



Weak oversized boxes damage these watermelons and make handling and storage difficult. The boxes are very heavy when loaded (34 kg (76 lb)) and they are too wide and too long to be handled carefully. The boxes are too big for a standard pallet, causing pallet overhang and crushing of the box and melons.

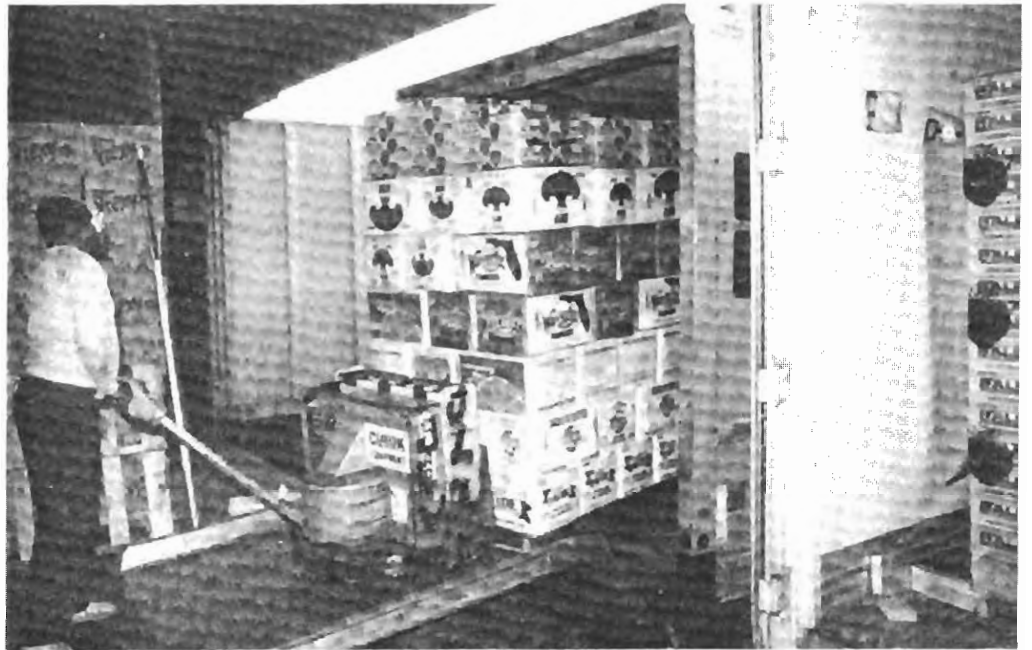

A mixed load of fruit unitized with clear plastic netting is transferred by a pallet jack to a local delivery truck.

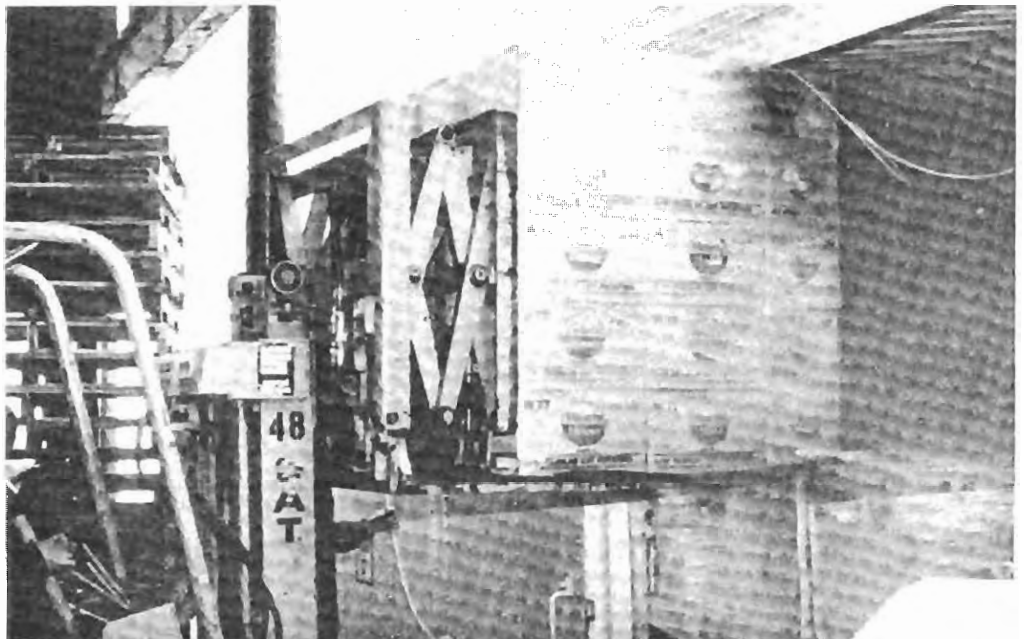

A slipsheet load of frozen potatoes unitized with film wrap is removed from a rail boxcar by a forklift with a special push/pull attachment.

Slipsheets

Slipsheets are used by some shippers because they cost less than pallets. They also eliminate the cost of transporting and returning pallets. A special forklift is needed to transfer slipsheet loads to and from the pallets at the shipper's and receiver's distribution center. If a receiver does not have the proper handling equipment, the packages are unloaded by hand onto pallets for placement in storage. Shipping containers on slipsheets are cross-stacked, film wrapped, or otherwise unitized with cornerboards and strapping.

Slipsheets made of fiberboard or plastic must be strong enough to be clamped and pulled onto the forklift tines or plate for lifting while fully loaded. Fiberboard slipsheets should be wax impregnated when used in wet conditions. Slipsheets used in transportation equipment should have holes for air circulation under the load. The use of slipsheets in refrigerated transportation equipment with shallow floor channels is not recommended due to the need for adequate air circulation under the load.

Labeling and Branding

Labeling of shipping containers helps to identify and advertise the products and assists receivers in storing and retrieving them. Fiberboard boxes can be colorfully preprinted with labels. Other container materials require glued, stamped, or stenciled labeling. Some high quality fruit and vegetables are individually branded for consumer identification with small colorful trademark stickers. Some shippers also provide selection, storage, and recipe brochures for the consumer. All containers should be clearly labeled and branded in the language of the destination country with the following information:

- common name of the product.
- net weight, count, and/or volume.
- brand name as well as name and address of the packer or shipper.
- country of origin.
- size and grade, when standards are used.
- recommended storage temperature.
- special handling instructions.
- name of U.S. approved fungicides or bactericides used in packaging.

Labeling of consumer packages is mandatory under FDA regulations. In addition to the name of product, net weight, and name and address of the manufacturer, packer or distributor; processed items must have all ingredients listed. The U.S. Customs Service requires the outermost container in which the products will ordinarily reach the ultimate U.S. purchaser must be marked to show the country of origin. Packaging helps sell tropical fruits and vegetables, plants, and cut flowers; especially when the shipping containers are attractively labeled and provide the necessary product protection.

Precool Produce to Ensure Quality

Removal of field heat by the process of precooling to a recommended storage temperature and relative humidity is absolutely necessary to maintain the quality of fruits, vegetables, plants, and cut flowers. The quality of most products will rapidly deteriorate if field heat is not removed before loading into transportation equipment. The rate of respiration and ripening increases two to three times for every 10°C (18°F) above the recommended storage temperature.

Refrigerated transportation equipment is designed to maintain temperature and should not be used to remove field heat from products packed in shipping containers. The refrigeration units also are not capable of raising or controlling the relative humidity.

A high temperature difference between the refrigeration unit evaporation coil and the product will increase the loss of product moisture. This will cause the evaporator to frost and the products to shrivel or wilt and weigh much less. Most fruits and vegetables have a water content between 80 and 95%.

Factors

Precooling extends product life by reducing:

- field heat.
- the rate of respiration (heat generated by the product).
- the rate of ripening.
- the loss of moisture (shriveling and wilting).
- the production of ethylene (ripening gas generated by the product).
- the spread of decay.

The success of precooling is dependent on:

- time between harvest and precooling.
- type of shipping container if product is packed beforehand.
- initial product temperature.
- velocity or amount of cold air, water, or ice provided.
- final product temperature.
- sanitation of the precooling air or water to reduce decay organisms.
- maintenance of the recommended temperature after precooling.

Precooling should occur as soon as possible after harvest. Harvesting should be done in early morning hours to minimize field heat and the refrigeration load on precooling equipment. Harvested products should be protected from the sun with a covering until they are placed in the precooling facility.

Many products are field or shed packed and then precooled. Wirebound wood or nailed crates or wax impregnated fiberboard boxes are used for packed products that are precooled with water or ice after packing. Precooling of products packed in shipping containers and stacked in unitized pallet loads is especially important as air circulation around and through the packaging may be limited during transportation and storage.

Precooling is particularly important for products which produce a lot of heat. The following are examples of products which have high respiration rates and short transit and storage lives:

artichokes	brussels sprouts	onions, green
asparagus	carrots, bunched	okra
beans, lima	corn, sweet	parsley
beans, snap	endive	peas
bean sprouts	kale	raspberries
blackberries	lettuce	spinach
broccoli	mushrooms	strawberries
		watercress

Methods

The choice of precooling method depends on the nature, value, and quantity of the product as well as the cost of labor, equipment, and materials. Precooling methods include:

- room cooling—stacking containers of products in a refrigerated room. Some products are misted or sprayed with water during room cooling.
- forced air cooling or wet pressure cooling—drawing air thru stacks of containers of products in a refrigerated room. For some products, water is added to the air.
- hydrocooling—flushing product in bulk tanks, bins, or shipping containers with a large quantity of ice water.
- vacuum cooling—removing heat from products packed in shipping containers by drawing a vacuum in a chamber.
- hydrovacuum cooling—adding moisture to products packed in shipping containers before or during the vacuum process, to speed the removal of heat.
- package-icing—injecting slush or crushed ice into each shipping container of product. Some operations use bulk containers.

Portable ice plants, hydrocoolers, vacuum coolers, forced-air coolers, and package-icing machines are available for use in the fields. This equipment is useful for remote or small scale operations that cannot justify investment in a fixed precooling facility. Mounted on skids or dollies, the equipment can follow the harvest from field to field and be shared by many growers.

Hydrocooling and vacuum cooling are the fastest cooling methods. Cooling times of one half hour are possible. Products and packaging must be able to withstand direct water contact in hydrocooling. In vacuum cooling, it is necessary the products have a large surface area, low density, and high moisture content. The boxes and wrapping must allow ventilation of heat.

Forced air cooling can take 1 or 2 hours depending on the amount of packaging, while room cooling may take 24 to 72 hours. Packaging must allow ventilation of heat for these methods to be successful. Package-icing provides effective cooling and a high relative humidity for products and packaging that can withstand direct contact with ice.

Many tropical fruit, vegetables, plants, and cut flowers require much less cooling than products which are cooled to 0°C (32°F). All products should be precooled as near as possible to the recommended storage temperature and relative humidity. Product temperatures should be taken in sample shipping containers by inserting an electronic thermometer into the product. The data should be recorded for future reference.

Tables in the sections on Fruits, Vegetables, and Specialty Products; Potted Plants; and Cut Flowers and Florist Greens provide lists of products and their recommended temperatures, relative humidities, and approximate transit and storage lives. Recommended precooling methods also are given for individual fruits and vegetables. Plants and flowers are room cooled. Cut flowers also are forced-air cooled after packing.

Precautions

Since most tropical products are sensitive to chilling injury, care must be taken not to precool or store the products below the recommended temperature. Often the visible effects of chilling injury are delayed until the product is offered for retail sale. These effects include failure to ripen properly, pitting, decay, watery breakdown, and discoloration in fruits and vegetables. Flowers and plants lose florets or foliage, fail to open, discolor, or wilt.

All products are sensitive to decay. Precooling equipment and water should be sanitized continuously with a hypochlorite solution to eliminate decay producing organisms. Care also must be taken not to allow products to warm up after precooling. Condensation on cool product surfaces at higher air temperatures also spreads decay.

The method of transportation, condition of the transport equipment, loading method, and transit and storage practices affect the success of precooling. If the recommended temperature and relative humidity are not maintained after precooling, product quality will deteriorate.

Precooling Equipment

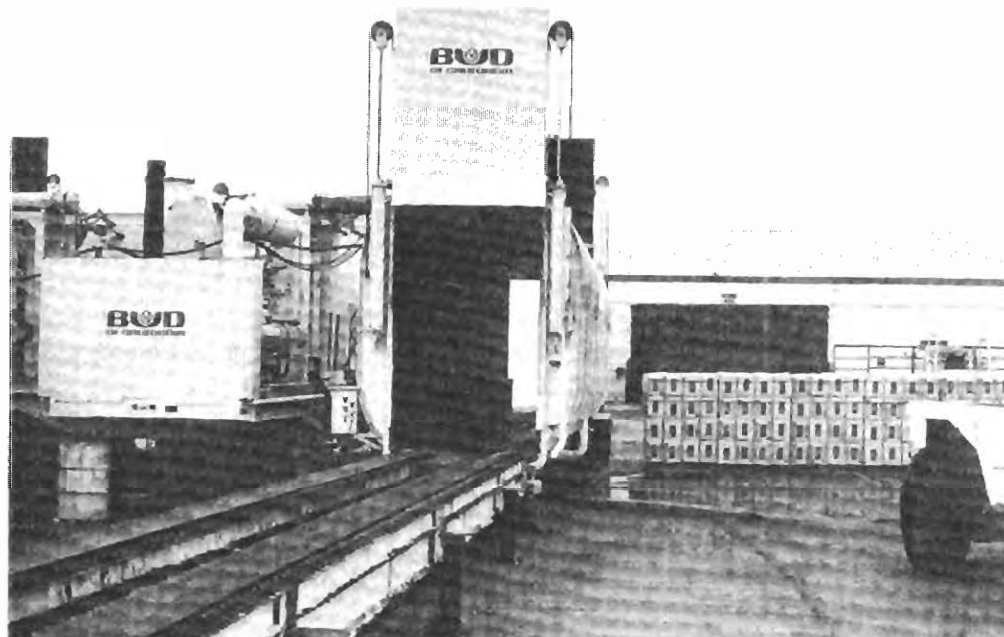

A vacuum cooler can be used for lettuce, celery, and other leafy vegetables. Some products are wetted before going into the cooler to speed the cooling process and reduce moisture loss from the product. Hydrovac coolers add water inside the vacuum chamber.

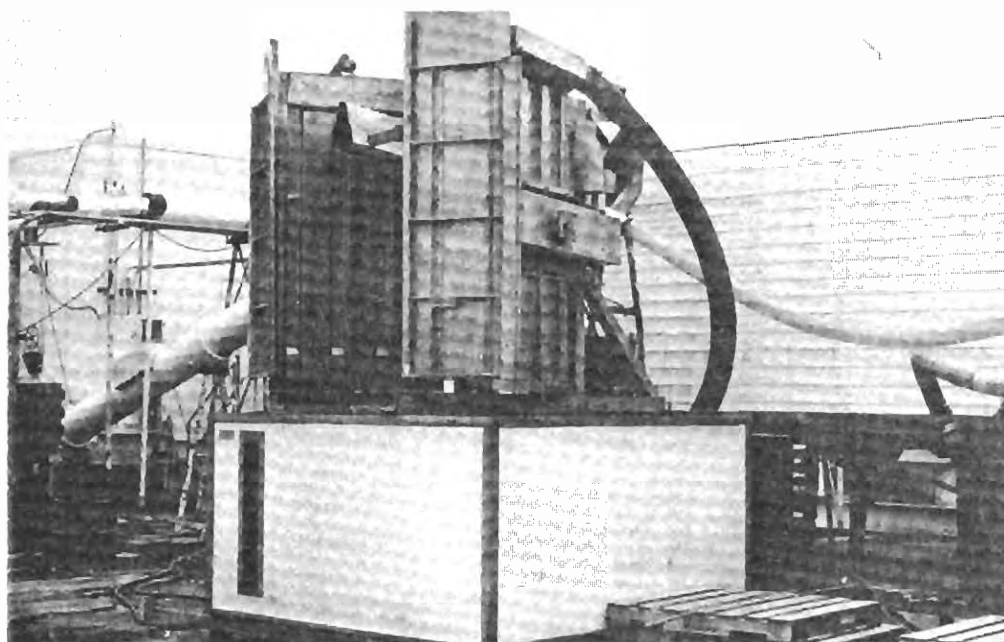

This pallet icing machine is used to inject slush ice into every shipping container in pallet loads of broccoli. It also could be used to ice brussels sprouts, cantaloupe, bunched carrots or radishes, green onions, kale, kohlrabi, leeks, parsley, and sweet corn.

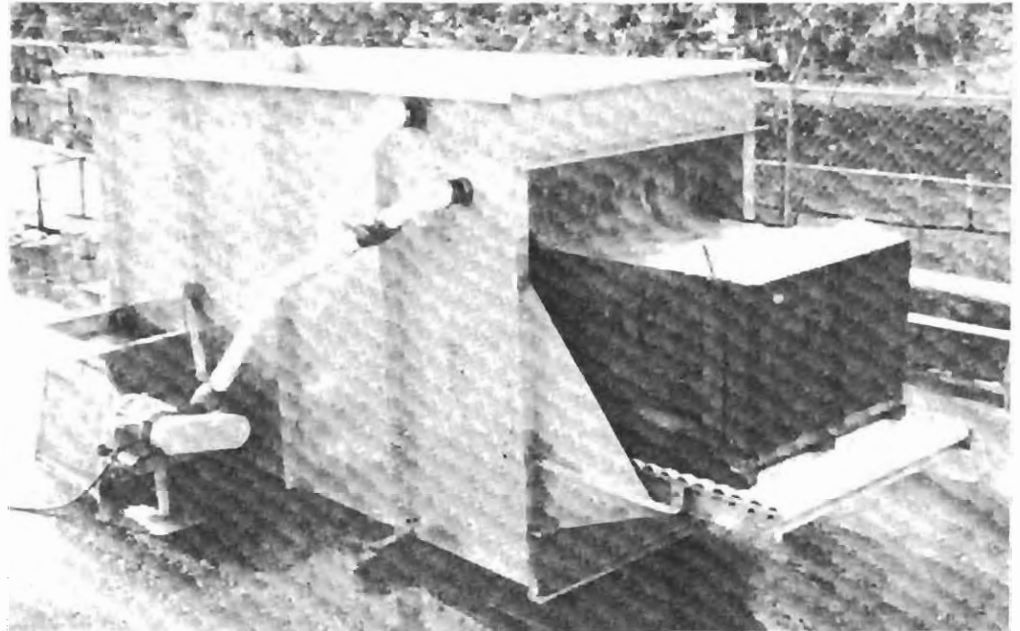

A mobile hydroslush chiller which can be used for pallet bins of artichokes, beans, brussels sprouts, broccoli, cantalopes, caullower, cucumbers, peas, radlshes, sweet corn, and turnips prior to packing. This machine must be connected to a mobile ice making plant.

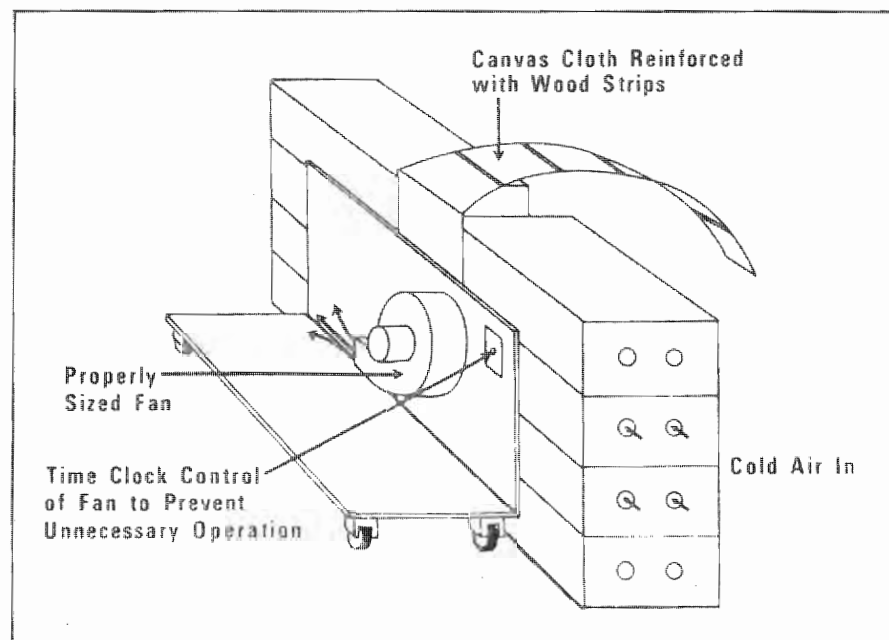

A portable forced air precooling unit as illustrated can be constructed at low cost and placed in a refrigerated storage area. Source: Rij, Thompson, and Farnham (21).

Choose the Best Mode of Transportation

After precooling, the products must be properly loaded and transported at or near the recommended storage temperature and relative humidity to maintain quality. The design and condition of the transport equipment, and the loading method used are critical to maintaining product quality. The mode of transportation and the carrier should be chosen carefully.

Factors

The mode of transportation and type of equipment used should be based on:

- destination.
- value of the product.
- degree of product perishability.
- amount of product to be transported.
- recommended storage temperature and relative humidity.
- outside temperature conditions at origin and destination points.
- time in transit to reach destination by air, land, or ocean transport.
- freight rates negotiated with the carriers.
- quality of transportation service.

Reliability and quality of transportation service provided by different carriers must be carefully considered along with the rates charged. Services and schedules are established or modified weekly. Sometimes service is abruptly withdrawn. Shippers should contact air and ocean port authorities at their origin and destination locations to receive the most current information on available services. Local trade publications also are excellent sources of information, as many carriers and their agents advertise their schedules and destinations.

Refrigerated trailers and van containers are recommended for most high volume products with transit and storage lives of a week or more. After transit, there must be enough remaining product life for marketing. Carriers utilizing trailers and containers can offer a door-to-door service. This reduces handling, exposure, damage, and theft of the products.

Air cargo containers also can be used to provide a door-to-door service. Products transported by air are generally high-value and highly perishable. Freight costs are higher by air. Transit times, however, are in terms of hours instead of days.

Many products are shipped in unrefrigerated air containers or on air cargo pallets. This requires close coordination at the origin and destination airports to protect the products when flights are delayed. Cold storage facilities at airports are needed to ensure product quality. Refrigerated air containers are available and should be used when possible.

Products which can be shipped in refrigerated trailers and van containers are sometimes shipped by air to take advantage of brief market opportunities, such as the beginning of a season when prices are high and supply is limited. Often an importer who is first to receive a certain product is able to build goodwill and increase sales throughout the season.

Equipment

The following transportation equipment is available:

- air cargo containers—for air and highway transport.
- air cargo pallets with netting—for air and highway transport.
- highway trailers—for highway transport only.
- piggyback trailers—for rail, highway, and roll-on/roll-off ocean transport.
- van containers—for rail, highway, and lift-on/lift-off ocean transport.
- general cargo ocean vessels—handling palletized or individual shipping containers in refrigerated holds of the ship.
- rail boxcars—handling palletized or individual shipping containers.

Information on the cubic capacity and weight limits of air cargo containers and pallets, and refrigerated trailers and van containers is given at the end of this section.

Refrigeration Systems

The following refrigeration systems are available:

- mechanical—using diesel generated electric power over the road and aboard ocean vessels. Van containers are plugged into electrical power at depots and aboard ships.
- cryogenic—using liquid or gaseous nitrogen or carbon dioxide, which is vented into the cargo compartment. Some products such as leafy green vegetables are not compatible with carbon dioxide refrigeration.
- dry ice—using solid blocks of carbon dioxide in special trays or compartments in the cargo area or within individual shipping containers. Shippers must check with airlines prior to using dry ice. If permitted, the containers and accompanying documents must be properly marked to show the amount of dry ice used. Some products such as leafy green vegetables are not compatible with dry ice. Direct contact with dry ice will injure fresh products.
- wet ice—using ice within individual shipping containers or on top of a load of containers, either as a supplement or instead of mechanical refrigeration. Many airlines refuse to handle shipping containers with wet ice due to the risk of expensive damage from leaking containers. Airlines that do permit wet ice require that it be placed in sealed polyethylene bags inside a leakproof container with a moisture absorbent pad.
- gel refrigerant—using frozen containers of chemical eutectic gel to maintain temperature within shipping containers. This is the refrigeration system preferred by most airlines.
- ventilation—using fresh air exchange in the refrigeration system or separate vents to protect products from a buildup of carbon dioxide or ethylene.
- multitemperature—using a mechanical or cryogenic system to provide two or three temperature conditions in separate compartments of a trailer.
- modified atmosphere—adding a specific percentage of nitrogen or carbon dioxide gas to pallet bags or the cargo compartment of refrigerated trailers or van containers to reduce product decay, respiration, and ripening of certain products.

Insurance

Regardless of the method of transportation and refrigeration chosen, shippers should purchase trip insurance for each load to reduce their risk of loss. The liability of carriers, importers, brokers, and receivers is often limited. It is difficult to prove negligence when the products are handled by so many different parties from the field to the consumer. Shippers should plan on placing a temperature recorder in the cargo compartment during loading to monitor air temperature during transportation. The use of these recorders is described in the section on Proper Loading.

Design Features

Long distance transportation through tropical and frigid climates requires rugged well-designed equipment to withstand the transit environment and protect the products. Desirable features in refrigerated trailers up to 14.6 m (48 ft) long and van containers up to 12 m (40 ft) long include:

- 41,843 kJ/h (40,000 BTU/h) refrigeration capacity at 38°C (100°F) ambient, 2°C (36°F) return air temperature.
- a continuously operating high capacity evaporator blower for more even product temperatures and higher relative humidities.
- a solid return air bulkhead at the front of the trailer to ensure air circulation throughout the load.
- vertical ribs on the rear door to assist in air circulation.
- adequate insulation and provisions for heating, when used in areas with extreme weather.
- deep floor grooves or channels, from 51 to 76 mm (2 to 3 in) in depth to provide an adequate cross-sectional area for air circulation under loads placed directly on the floor.
- supply-air temperature sensing of the operation of the refrigeration unit to reduce product chilling and freezing injury.
- provisions for ventilation to prevent ethylene or carbon dioxide buildup, particularly in loads of:

apples	brussels sprouts	plants
apricots	cabbage	kiwifruit
avocados	cauliflower	leafy greens
bananas	cherimoya	lettuce
Belgian endive	cucumbers	plantains
broccoli	cut flowers	

- provisions for application of modified atmospheres with reduced oxygen and elevated carbon dioxide levels, particularly in loads of:

apples	bananas	mangoes
asparagus	cherries	pears
avocados	kiwifruit	strawberries

- air-ride suspension to reduce the amount of shock and vibration transferred to the shipping containers and the products inside.

Transport Equipment



A refrigerated LD-3 air cargo container with a compartment for dry ice on the upper left hand side.

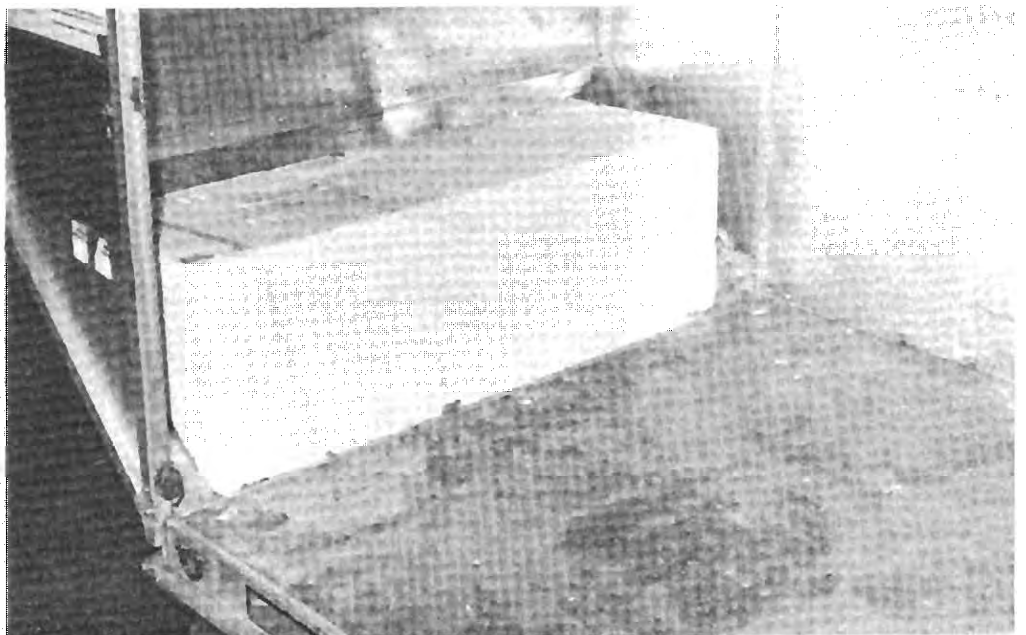

Polystyrene foam blocking used to allow stable loading of boxes of strawberries, papaya, pineapples, and other products over the sloped surface of an LD-3 container.

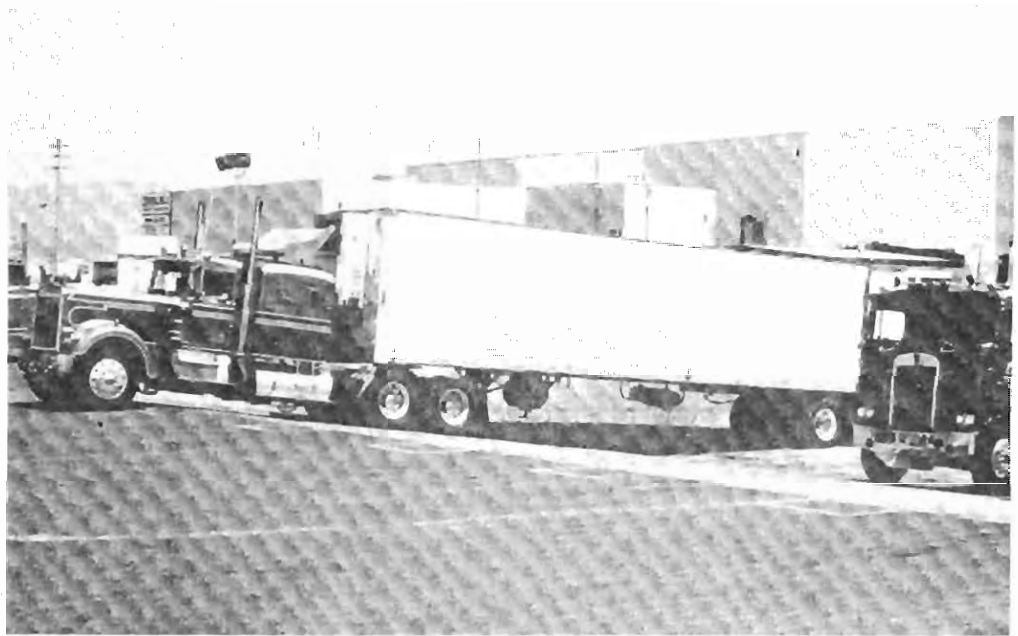

Refrigerated highway trailers up to 14.6 m (48 ft) long carry 85 percent of the fruits, vegetables, plants, and flowers across the United States.



Refrigerated piggyback trailers on railroad flatcars and roll-on/roll-off ocean vessels are used for long distance hauls from California, Florida, Puerto Rico, and Central America. They are driven to and from railroad and ocean terminals to points of origin and destination.

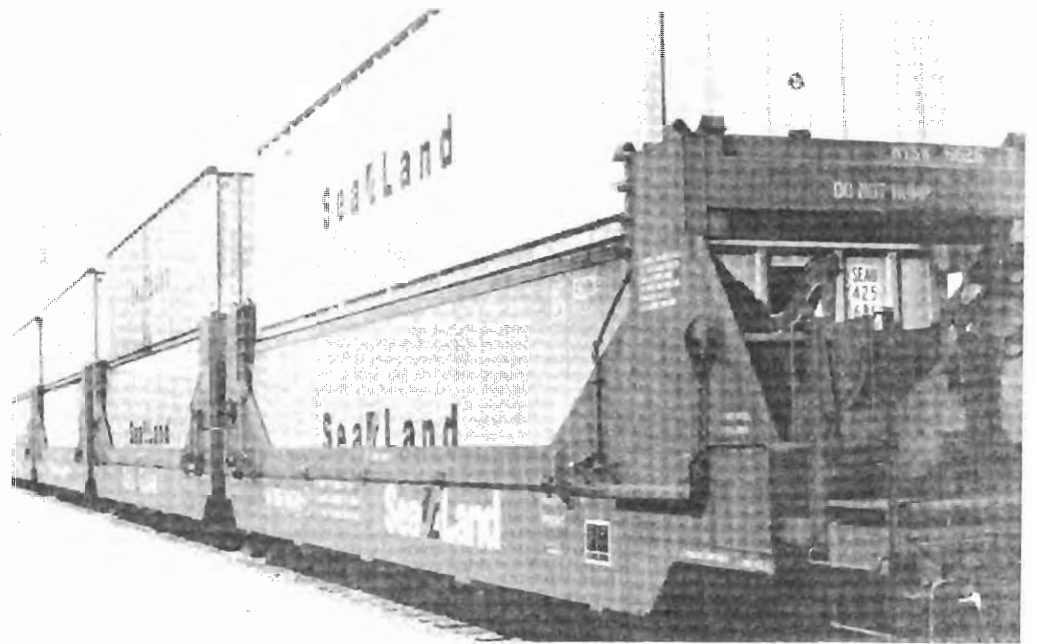

Double-stack van container trains are competing with highway and piggyback trailers for westbound backhaul cargo in the United States. Refrigerated van containers also are transported on chassis on railroad flatcars and on chassis over the road, to and from ocean terminals as shown below.

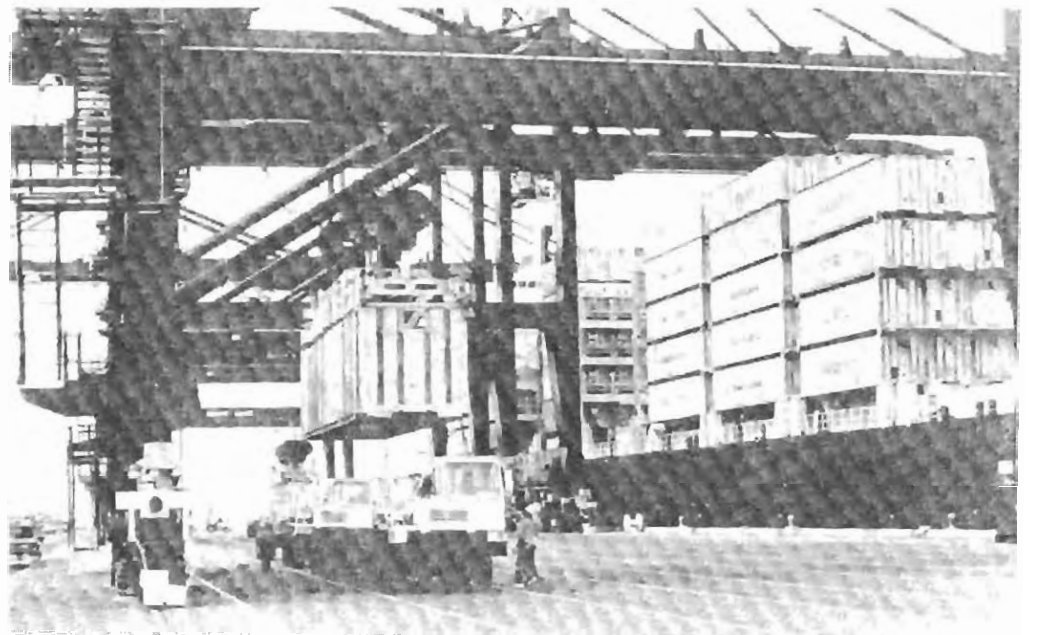



This 18.3 m (60 ft) long mechanically refrigerated railroad boxcar is used for apples, carrots, citrus, onions, and potatoes as well as a limited amount of broccoli, celery, lettuce, and tomatoes.

The capacities and dimensions of air cargo containers, air cargo pallets, refrigerated trailers, and refrigerated van containers vary from carrier to carrier due to differences in equipment design and manufacture. Carriers should be consulted well in advance of shipping for specifications, availability, and rates. Many carriers provide valuable assistance and information on loading and operating their equipment.

Room for air circulation must be provided in transport equipment loaded with agricultural products. The nature of the product, type of packaging, and loading method affect air circulation as well as the total weight and the volume occupied by the load.

Maximum cargo weights are limited by carriers to comply with restrictions on particular transport and handling equipment or limits enforced by Government agencies to protect roads and bridges. Due to light product density or load limits, many loads do not utilize the maximum rated weight capacity of the transport equipment.

Air Cargo Containers:

- refrigerated:

- LD3: Maximum cargo weight: 1400 kg (3100 lb)
Dry ice system: 56 kg (125 lb) CO₂
Internal measure: 1460 × 1430 × 1410 mm (57 × 56 × 55 in)
Useable volume: 3.5 cu m (122 cu ft)
Aircraft: 747, L1011, DC10, A300, A310, 767
- LD7/9: Maximum cargo weight: 5450 kg (12,000 lb)
Dry ice system: 91 kg (200 lb) CO₂
Internal measure: 2940 × 2020 × 1430 mm (115 × 79 × 56 in)
Useable volume: 8.6 cu m (305 cu ft)
Aircraft: 747, L1011, DC10, 707 and DC8 freighters
- LD5/11: Maximum cargo weight: 3200 kg (7100 lb)
Dry ice system: 56 kg (125 lb) CO₂
Internal measure: 2940 × 1430 × 1430 mm (115 × 56 × 56 in)
Useable volume: 6.0 cu m (210 cu ft)
Aircraft: 747, L1011, DC10

- insulated:

- LD3: Maximum cargo weight: 1400 kg (3100 lb)
Internal measure: 1534 × 1562 × 1620 mm (60 × 62 × 64 in)
Useable volume: 3.7 cu m (131 cu ft)
Aircraft: 747, L1011, DC10, A300, A310, 767

- dry (uninsulated):

- LD3: Maximum cargo weight: 1500 kg (3300 lb)
Internal measure: 1450 × 1453 × 1550 mm (57 × 57 × 61 in)
Useable volume: 4.3 cu m (153 cu ft)
Aircraft: 747, L1011, DC10, A300, A310, 767
- LD7/9: Non-structural igloo pallet container, contoured or rectangular, with fabric weather cover and full net.
Structural igloo pallet container, contoured or rectangular
Maximum cargo weight: 4350 kg (9600 lb) on 747 aircraft
3700 kg (8150 lb) on L1011 aircraft
Internal measure: 2160 × 3100 × 1550 mm (85 × 122 × 61 in)
Useable volume: 10 cu m (348 cu ft)
Aircraft: 747, L1011, DC10, 707 and DC8 freighter
- LD11: Structural igloo pallet container, contoured or rectangular.
Maximum cargo weight: 2900 kg (6400 lb) on 747 and DC10
2500 kg (5500 lb) on L1011 aircraft
Internal measure: 1470 × 3100 × 1550 mm (58 × 122 × 61 in)
Useable volume: 7 cu m (229 cu ft)
Aircraft: 747, L1011, DC10

- fiberboard air cargo containers, shipper supplied:

Fiberboard containers can be lined with 19 mm (3/4 in) polystyrene foam board or have a polystyrene foam box insert. For refrigerated shipments, the containers are wax impregnated and lined with a film bag before the foam board is put in place. Refrigeration should be supplied with dry ice or gel pack, as many air carriers do not permit water ice on board. Those that do permit ice require it be sealed in plastic bags and the container be leakproof.

- EH:** Maximum cargo weight: 132 kg (290 lb)
 External measure: 920 × 560 × 560 mm (36 × 22 × 22 in)
 Maximum top loading capability: 272 kg (600 lb)
 Aircraft: All
- E:** Maximum cargo weight: 218 kg (482 lb)
 External measure: 1070 × 740 × 650 mm (42 × 29 × 25 in)
 Maximum top loading capability: 272 kg (600 lb)
 Aircraft: All
- CO8:** Maximum cargo weight: 866 kg (1909 lb)
 External measure: 1070 × 1470 × 1140 mm (42 × 58 × 45 in)
 Maximum top loading capability: 272 kg (600 lb)
 Aircraft: 747, L1011, DC10, A300, A310, 767
- C07:** Insert for LD3 containers.
 Maximum cargo weight: 1360 kg (3000 lb)
 External measure: 1480 × 1420 × 1480 mm (57 × 56 × 57 in)
 Maximum top loading capability: 544 kg (1200 lb)
 Aircraft: 747, L1011, DC10, A300, A310, 767

Air Cargo Pallets:

- P1P:** External Measure: 2240 × 3180 mm (88 × 125 in)
 Maximum cargo weight: 4500 kg (9920 lb) on 747 aircraft
 3860 kg (8510 lb) on L1011 aircraft
 Maximum loaded height: 1630 mm (64 in), lower deck
 Useable volume: 10 cu m (341 cu ft)
 Aircraft: 747, L1011, DC10, A300
 Supplied with cargo nets.
- P6P:** External measure: 2430 × 3180 mm (96 × 125 in)
 Maximum cargo weight: 4500 kg (9920 lb)
 Maximum loaded height, main deck: 2438 mm (96 in)
 Useable volume, main deck: 16 cu m (561 cu ft)
 Maximum loaded height, lower deck: 1630 mm (64 in)
 Useable volume lower deck: 11 cu m (388 cu ft)
 Aircraft: 747, L1011, DC10, A300, A310, 767
 Supplied with cargo nets.

P9P: External measure: 1530 × 3180 mm (61 × 125 in)
Maximum cargo height: 3090 kg (6810 lb) on 747 and DC10
2635 kg (5810 lb) on L1011 aircraft
Maximum loaded height: 1630 mm (64 in), lower deck
Useable volume: 8 cu m (256 cu ft)
Aircraft: 747, L1011, DC10, A300
Supplied with cargo nets.

Refrigerated Trailers:

Many trailers are intermodal. Their upper coupler is designed for piggyback loading on railroad flatcars with deck-mounted hitches, attachment to similar hitches on roll-on/roll-off barges and vessels, and transport over the highway.

12 m (40 ft)	Maximum cargo weight: 22,680 kg (50,000 lb) Internal measure: 12 × 2.26 × 2.49 m (39.33 × 7.42 × 8.17 ft) Useable volume: 62 cu m (2188 cu ft)
13.7 m (45 ft)	Maximum cargo weight: 22,680 kg (50,000 lb) Internal measure: 13.84 × 2.19 × 2.36 m (45.42 × 7.17 × 7.75 ft) Useable volume: 66 cu m (2328 cu ft)
14.6 m (48 ft)	Maximum cargo weight: 22,680 kg (50,000 lb) Internal measure: 14.26 × 2.45 × 2.50 m (46.77 × 8.04 × 8.21 ft) Useable volume: 80 cu m (2825 cu ft)

Refrigerated Van Containers:

Containers are intermodal. They are stacked on ocean container vessels and transported one-high on railroad flatcars (COFC) or two-high in double-stack railcars. When mounted on chassis, they are transported on roll-on roll-off ocean vessels, highways, and railroad flatcars (TOFC). Due to refrigerated container shortages, some carriers require containers to be unloaded at their terminals in the importing country.

6 m (20 ft)	Maximum cargo weight: 19,050 kg (42,000 lb) Internal measure: 5.29 × 2.18 × 2.02 m (17.67 × 7.29 × 6.75 ft) Useable volume: 23.84 cu m (842 cu ft)
12 m (40 ft)	Maximum cargo weight: 20,866 kg (46,000 lb) Internal measure: 11.33 × 2.28 × 2.19 m (37.17 × 7.50 × 7.19 ft)
12 m (40 ft)	High Cube, 2.9 m (9.5 ft) high Maximum cargo weight: 20,866 kg (46,000 lb) Internal measure: 10.89 × 2.18 × 2.32 m (36.33 × 7.29 × 7.75 ft) Useable volume: 58.14 cu m (2,053 cu ft)

Check the Transport Equipment Before Loading

Most carriers check their transport equipment before presenting it to the shipper for loading. The condition of the equipment is critical to maintaining the quality of the products. Therefore, the shipper also should check the equipment to ensure it is in good working order and meets the needs of the product. Carriers provide guidance on checking and operating the refrigeration systems.

All transportation equipment should be checked for:

- cleanliness—the load compartment should be regularly steam-cleaned.
- damage—walls, floors, doors, ceilings should be in good condition.
- temperature control—refrigerated units should be recently calibrated and supply continuous air circulation for uniform product temperatures.

Shippers should insist on clean equipment. A load of products can be ruined by:

- odors from previous shipments.
- toxic chemical residues.
- insects nesting in the equipment.
- decaying remains of agricultural products.
- debris blocking drain openings or air circulation along the floor.

Shipper should insist on well maintained equipment and check for the following:

- damage to walls, ceilings, or floors which can let in the outside heat, cold, moisture, dirt, and insects.
- operation and condition of doors, ventilation openings, and seals.
- provisions for load locking and bracing.

For refrigerated trailers and van containers, the following additional checks are important:

- with the doors closed, have someone inside the cargo area check for light—door gaskets must seal. A smoke generator also can be used to detect leaks.
- the refrigeration unit should cycle from high to low speed when the desired temperature is reached and then back to high speed.
- determine the location of the sensing element which controls the discharge air temperature. If it measures return air temperature, the thermostat may have to be set higher to avoid chilling injury or freezing injury of the products.
- a solid return air bulkhead should be installed at the front of the trailer.
- a heating device should be available for transportation in areas with extreme cold weather.
- equipment with a top air delivery system must have a fabric air chute or metal ceiling duct in good condition.

Use Proper Loading Practices

Products requiring refrigeration should be thoroughly precooled prior to loading into transportation equipment. Product temperatures should be taken with an electronic probe thermometer and recorded on the bill of lading for future reference. The load compartment in the equipment also should be precooled to the recommended transport or storage temperature for the product. Ideally, the loading area should be enclosed and refrigerated with dock seals at the trailer or container doors.

Proper loading practices are critical to maintaining temperature and relative humidity, protecting the products from impact and vibration forces in transit, and preventing insects from entering the load. Special care must be taken when shipping mixed loads. The products must be compatible.

Methods

Basic loading methods include:

- bulkloading, by machine or hand, of unpackaged commodities.
- hand loading individual shipping containers, with or without pallets.
- unit loading of palletized or slipsheet loads of containers with pallet jacks or forklifts.

Air Circulation

Inadequate provisions for air circulation will ruin a load, even in well designed transportation equipment. When possible, shipping containers should be kept off shallow floors and away from flat sidewalls by using pallets, racks, and dunnage. Room for air circulation must be provided under, around and through the load to protect the products from:

- heat gain from the outside air during hot weather.
- heat generated by the produce through respiration.
- concentrations of ethylene from ripening of the products
- heat loss to the outside air during extreme cold weather.
- chilling injury or freezing injury during operation of the refrigeration unit.

Temperature Control

Shippers using refrigerated transport equipment should follow the carrier's recommendations on loading and setting the temperature of the equipment's load compartment to avoid chilling injury or freezing injury to the products. Discharge air may be colder than the set-point temperature if the refrigeration system operates on return air temperature sensing.

Many carriers advise setting the thermostat temperature 1° to 3°C (2-6°F) higher than the recommended temperature of 0°C (32°F) for chilled products. This depends on the design of the transportation equipment. Newer equipment with supply-air temperature sensing and good air circulation can be operated closer to the recommended temperature. For most tropical fruits and vegetables and plants which have recommended temperatures in the 10° to 21°C (50-70°F) range, the thermostat is set at or near the recommended temperature.

Bracing

Loads should be secured with some of the following materials to prevent vibration and impact damage in transit:

- aluminum or wood load locks.
- fiberboard honeycomb fillers.
- wood blocking and nailing strips.
- inflatable kraft paper air bags.
- cargo nets and straps.
- wood load gates constructed of 25 mm × 102 mm (1 in × 4 in) material.

Pest Control

Shippers should avoid loading at night. Insects attracted by light can enter the load and cause problems upon inspection at destination. The loading area should be enclosed to prevent insects from reinfesting treated and packaged products.

Fumigations for pest control inside loaded transportation equipment are usually done under supervision by APHIS in accordance with the necessary treatment schedule for a particular product and insect. Cold treatment of certain products during transportation also is used to kill insects. This involves strict temperature control throughout the load for up to 2 weeks.

Air Cargo Equipment

Air cargo containers are loaded by hand or with forklifts when using fiberboard LD-3 container inserts. Polystyrene foam triangular inserts, wood blocking and fiberboard dunnage are recommended to brace shipping containers and provide a level platform on the sloped surface of LD-3 containers. Refrigerated air cargo containers should be used when available.

Air cargo pallets are loaded by hand or with forklifts. The loads should be unitized with straps, tape, or cross-stacking of the shipping containers. A weatherproof cover can be placed over the load along with the required cargo netting, provided the pallet load is protected from sunlight.

**Trailers and
Van Containers**

For refrigerated trailers and van containers the following loading practices are recommended:

- precool the trailer or container to the recommended transport or storage temperature. Turn off the refrigeration unit during loading if the loading area is not refrigerated. Otherwise the evaporator will frost due to the warm air drawn in by the unit.
 - unit loads must be thoroughly precooled as air circulation to some of the shipping containers may be limited. The containers should have openings for cooling and ventilation of product heat.
 - avoid loading tightly against flat side walls, use center-line loading for unitized loads.
 - secure unitized loads with dunnage between the walls and load.
 - do not block air circulation at the rear door.
 - secure the rear of both hand-stacked and unitized loads with straps, load gates, or load lock bars to prevent the load from shifting against the rear doors.
- Figures 9, 10, and 11 illustrate unit loading patterns. Figures 12 and 13 illustrate hand loading patterns.

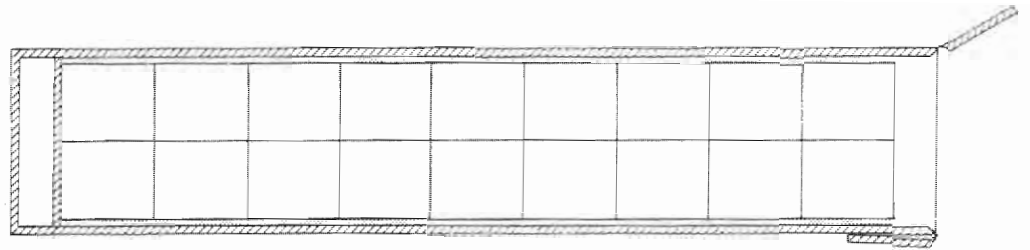

Figure 9. Top view of pattern for straight in loading of palletized unit loads. Centerline loading of the pallets is recommended in equipment with flat side walls.

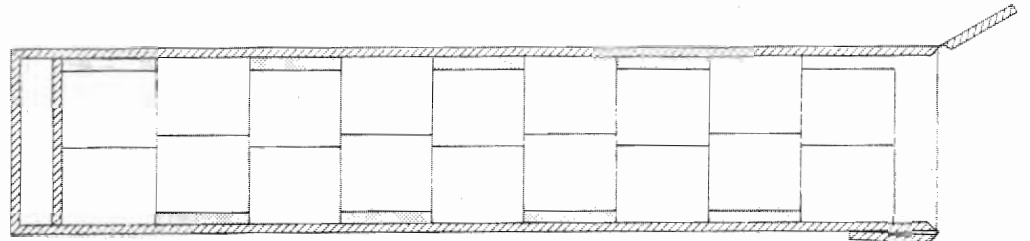

Figure 10. Top view of an offset loading pattern for straight in loading of palletized unit loads to reduce wall contact in equipment with flat side walls. Center-line loading is preferred.

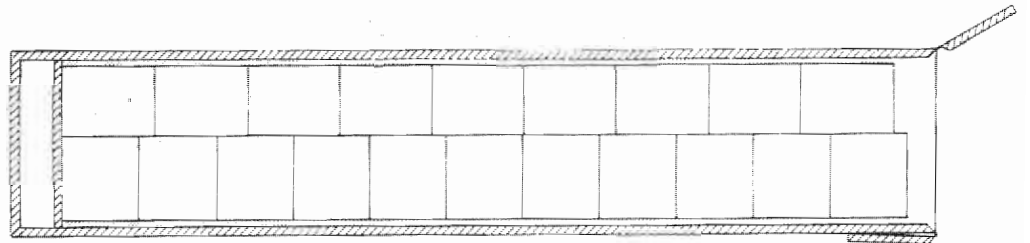

Figure 11. Top view of pattern for alternate loading of pallets used to increase the number of pallet loads when the weight of the product permits. In equipment with top air delivery and shallow floors, it is necessary that the pallets have adequate openings along all four sides for air circulation and forklift and pallet jack entry. Double-faced block pallets should be used for this type of loading.

Top Air Delivery

For refrigerated trailers and van containers with top air delivery, these additional practices are necessary to maintain product quality:

- hand-stacked loads should be arranged with lengthwise air flow channels, evenly spaced, on every other layer, to ventilate product heat (respiration). This is illustrated in Figure 12.
- header stacks must be provided at the front bulkhead of the trailer or van container in hand-stacked loads to connect all the lengthwise channels and allow the air to return to the evaporator.

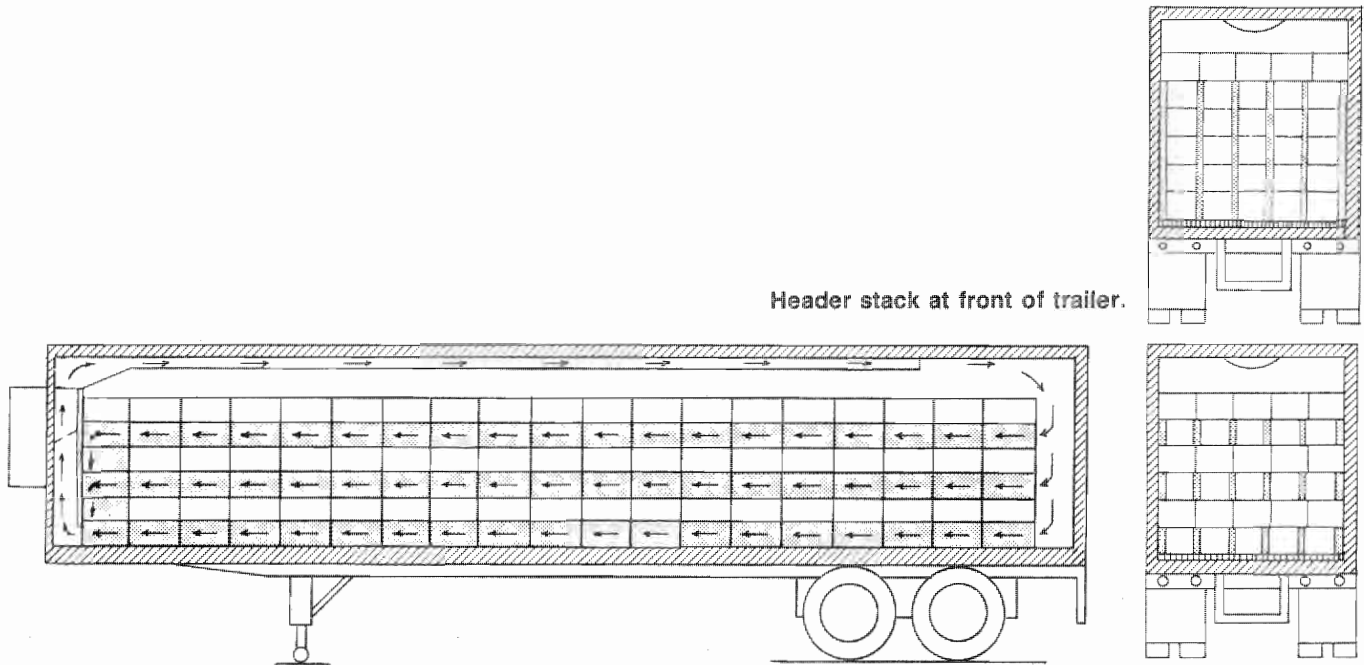

Figure 12. Side, end, and detail views of the recommended air-flow hand loading pattern for trailers or containers with top air delivery. The boxes must be strong enough to permit offset stacking without crushing. A solid return air bulkhead must be installed at the front to prevent air from bypassing the load. A header stack is needed at the front of the trailer or container to connect the horizontal air channels and allow the air to return to the evaporator. Pallets should be used in equipment with shallow grooved floors.

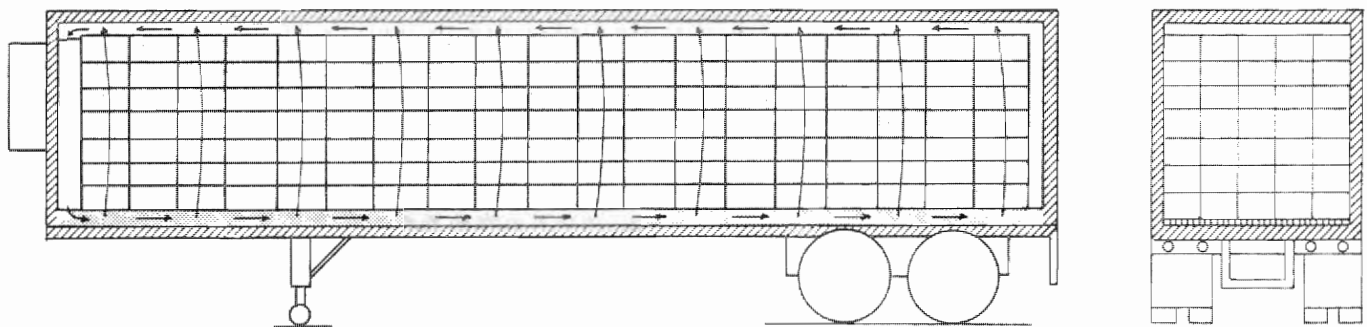

Figure 13. Side and end view of the recommended vertical air flow hand loading pattern for bottom air delivery trailers and containers. A solid return air bulkhead is a necessary feature of this system. The floor channels at the rear of the load must be blocked to force air through the load. Many researchers, shippers, and carriers feel that the bottom air delivery system provides for easier loading and more even product temperatures.

- fiberboard boxes must be strong enough to support the offset shipping containers stacked above.
- pallets should be used with hand-stacked loads to provide adequate air circulation in equipment with flat or shallow grooved floors.
- the load should not block the ceiling air chute or duct.

Bottom Air Delivery

For refrigerated trailers and van containers with bottom air delivery, these additional practices are necessary to maintain product quality:

- hand-stacked loads of shipping containers should have bottom to top ventilation slots which align in the stacks. Otherwise there should at least be small vertical air flow channels between containers as a result of the slight bulge in the sides of the containers.
- at least 13 mm (5 in) of space should be provided at the ceiling for return air circulation.
- the load should cover most of the floor surface to force more air through the load. The floor channels at the rear of the load should be blocked for this purpose.

Top-icing

Top-ice is used for certain products to supplement mechanical refrigeration and help maintain a high humidity. Refrigeration units on trailers and van containers cannot control relative humidity.

Top-ice on loads should be applied in rows instead of a solid mass, especially in bottom air delivery equipment. It is important not to block air circulation. The thermostat on top-iced loads should be set at 2°C (35°F) to prevent freezing of the ice into a solid mass which would block air circulation. Table 3 lists products that should or can be top-iced. These products also can be package-iced.

Table 3: Top-icing of products

Should be Top-iced:	Can be Top-iced:
beets with tops	artichokes, globe
broccoli	beet greens
carrots with tops	beets, topped
corn, sweet	brussels sprouts
endive	cantaloupes
escarole	carrots, topped
green onions	celeriac
parsley	chard
radishes with tops	kohlrabi
turnips with tops	leeks
watercress	mustard greens
radish greens	parsnips
spinach	radishes
turnip greens	rutabagas
turnips	

Temperature Recorders

In addition to trip insurance, all loads should have a small air temperature recorder placed between packages in the area where the warmest temperatures occur. Recorder companies recommend placement on top of the load, near a side wall, one-third of the way in from the rear doors, away from any direct discharge of refrigerated air. Railcars should have two or three recorders. In loads with top-ice or humidity above 95 percent, the recorders should be waterproof or enclosed in a plastic bag. Models are available for frozen food applications.

Shippers and receivers must follow the temperature recorder companies instructions on documenting the load, starting the recorder, reading the results, and returning it for calibration and certification if necessary. These steps are essential for settling claims over temperature management during transportation.

Mixed Loads

Groups of products suitable for transportation and storage together have been identified. They are listed in Table 4 in the Recommended Transit and Storage section. Tables 5-9 list products according to their sensitivity to chilling, freezing, moisture loss, ethylene, and odors.

Similar sized shipping containers should be loaded together in mixed loads for increased stability. Heavier shipping containers of products should be loaded first, distributed evenly across the floor of the trailer or container. Lighter shipping containers can then be placed against or on top of the heavier products. Load lock bars, load gates, and pallets placed in a vertical position can be used to separate and secure stacks of different sized shipping containers. To facilitate inspection of mixed loads at ports of entry, a representative sample of each commodity should be available near the door. This can minimize the unloading of cargo for examination.

Never load fruit, vegetables, or other food products with non-food cargos that provide any risk of contamination through transfer of odor or toxic chemical residues. The longer the transit time, the higher the risks in transporting mixed loads of agricultural products. Therefore it is essential that guidelines be followed as much as possible to maintain quality in distant markets.

Multi-Temperature Loads

Trailers with two or three separate compartments can be used to carry loads of products with different temperature requirements. Advance planning is required when loading multi-temperature trailers. The conditions provided by three compartment trailers may include -18°C (0°F), 0°C (32°F), 10°C (50°F), or ambient for products not requiring refrigeration.

The frozen compartment is usually located at the front of the trailer adjacent to the refrigeration unit. Movable bulkheads are placed between the compartments. Separate evaporators or ventilation between compartments provide temperature control for the nonfrozen products. Side doors are needed to access the forward compartments when the trailers are inspected at ports of entry or used to make multiple deliveries on a single run.

Modified Atmosphere Loads

Modified atmospheres of reduced oxygen and elevated carbon dioxide and nitrogen are provided to trailers and containers after loading is completed. The trailers and containers must be equipped with channels at the doorway for a plastic film curtain and gas ports for the application of the treatment.

The refrigeration unit, walls, ceiling, floor, and doors must adequately seal the inside of the cargo area from outside air. Otherwise the modified atmosphere will quickly dissipate. Warning labels must be applied to the equipment to warn that the atmosphere is not life supporting and that the cargo area must be properly ventilated before personnel enter to unload the cargo.

Ventilation

Atmospheres also are modified by adjusting vents on the trailers and containers to reduce either carbon dioxide or ethylene buildup. Leafy green vegetables are sensitive to carbon dioxide, while many products are sensitive to ethylene. In lieu of ventilation, potassium permanganate pads can be installed in the trailer or container at the refrigeration unit to absorb ethylene.

Loaded Equipment

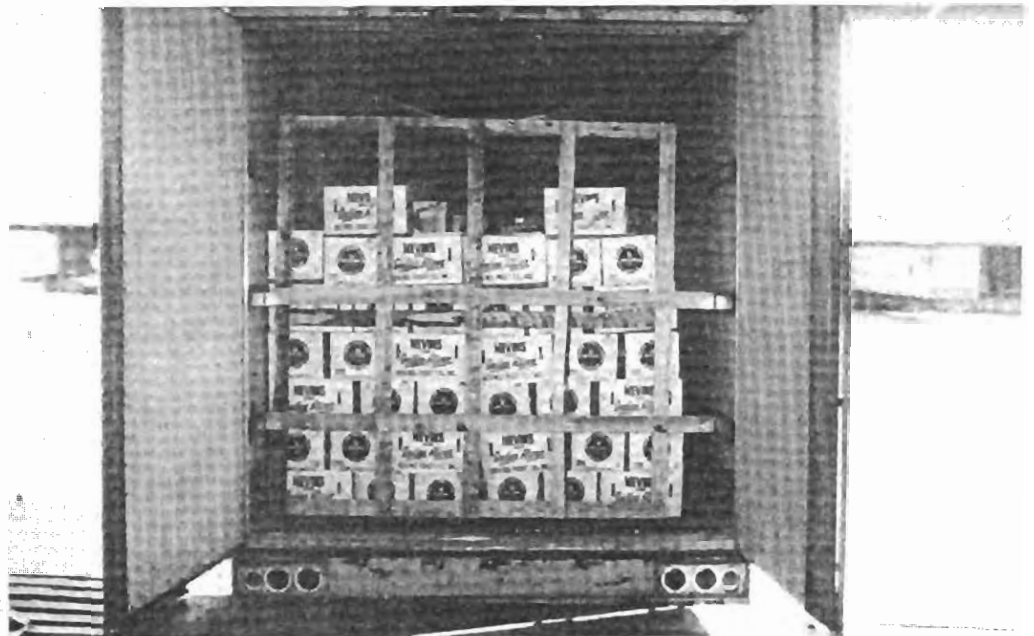

A wood load gate is braced against the rear of this load of citrus by wood load locks which are attached to the side walls of this refrigerated trailer.

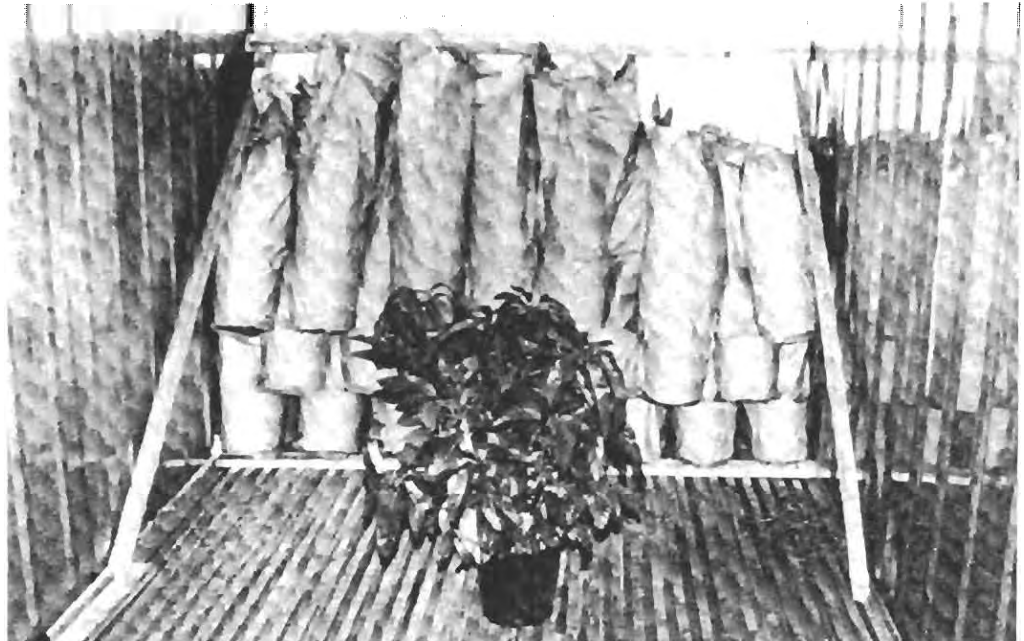

Sleeved potted foliage plants are stacked against the front bulk-head of this refrigerated van container. Wood blocking is used to secure the plants.

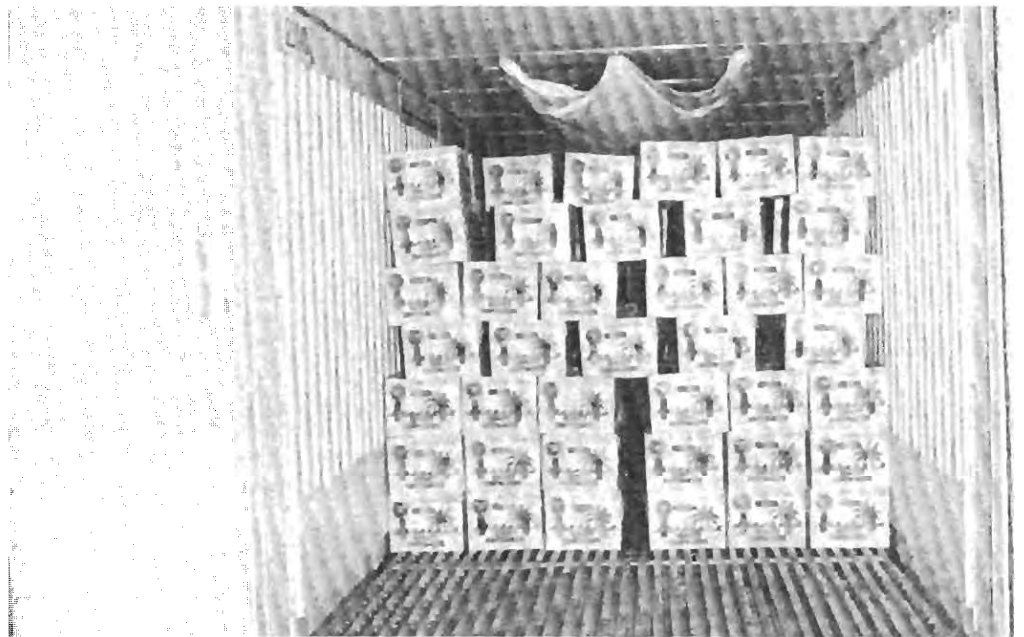

A horizontal air-flow loading pattern was used in this refrigerated van container load of cantaloupes.

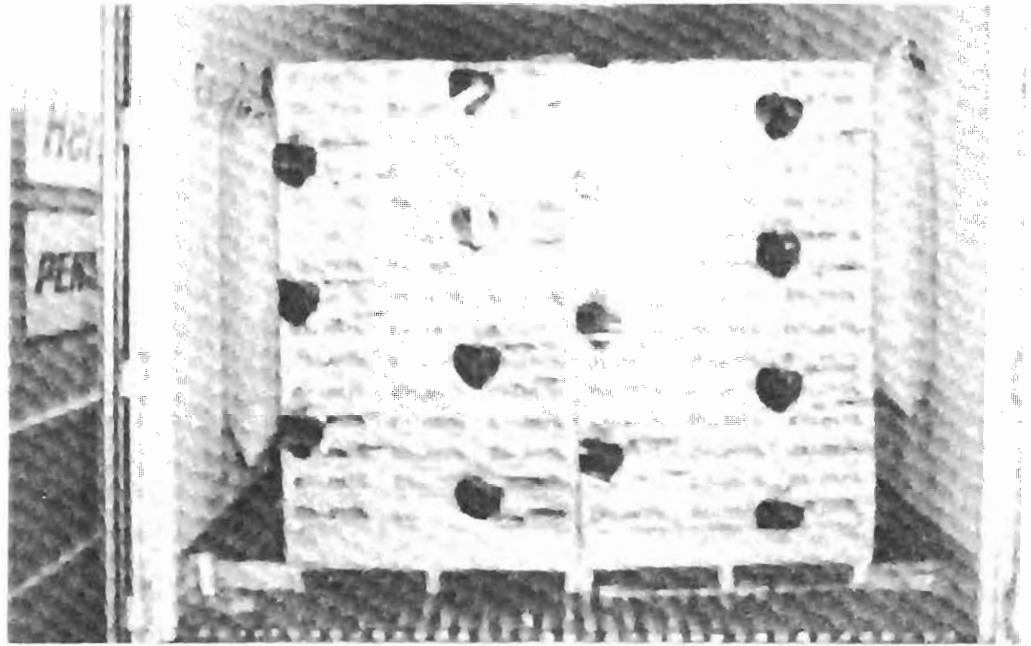

A centerline loading pattern is used for shipments of unit loads of strawberries in trailers with flat sidewalls. The strawberries are covered with plastic pallet bags and injected with a modified atmosphere including carbon dioxide. The pallets are braced against each other by inflatable kraft paper air bags and wood blocking.

Use Recommended Transit and Storage Procedures

Harvesting and packaging of most products should be closely coordinated with transportation to minimize time in transit and storage and maximize product freshness in the hands of consumers. Some products, however, can be consolidated in storage before or after transportation to obtain lower freight rates or higher prices.

During transportation and storage of loads of one product, the temperature and relative humidity should be as close as possible to the recommended levels to achieve the maximum product life. While transport refrigeration unit thermostats are sometimes set higher to avoid freezing injury, storage facilities are better able to control temperature and can provide conditions at the recommended level without damaging the products.

During transportation of refrigerated loads in trailers and van containers, the operation of the refrigeration unit and temperature of the load compartment should be checked regularly by the carrier. Gauges are provided for this purpose on most equipment. Many van containers also are provided with an exterior electronic or mechanical temperature recorder.

Mixed Loads and Storage

Many products are often transported in mixed loads or stored with other products. They must be compatible in terms of:

- recommended temperature.
- recommended relative humidity.
- production of ethylene.
- sensitivity to ethylene.
- production of odors.
- absorption of odors.

The following compatibility and sensitivity tables 4-9¹ take the above factors into account for transit and storage periods of 1 day or more. Compromises are made for temperature and humidity levels. In any of the groups, the more valuable products should determine the transit and storage conditions of the other commodities. Information on the compatibility of many tropical fruit and vegetables is limited to temperature and relative humidity conditions. Separate transit and storage are recommended for bananas, citrus, nuts, potatoes, onions, plants, cut flowers, florist greens, and nursery stock.

¹Sources of information for the compatibility and sensitivity tables are: Debney, Blacker, and Redding (5), Hardenburg, Watada, and Wang (7), Lipton and Harvey (10), Safeway Stores, Inc. (25), Society of American Florists (28).

Table 4: Compatability groups

Group 1: Fruits and vegetables, 0 to 2°C (32 to 36°F), 90-95% relative humidity. Many products in this group produce ethylene.

apples	grapes (without sulfur dioxide)	parsnips
apricots	horseradish	peaches
Asian pears	kohlrabi	pears
Barbados cherry	leeks	persimmons
beets, topped	longan	plums
berries (except cranberries)	loquat	pomegranates
cashew apple	lychee	prunes
cherries	mushrooms	quinces
coconuts	nectarines	radishes
figs (not with apples)	oranges* (Florida and Texas)	rutabagas
		turnips

*Citrus treated with biphenyl may give odors to other products.

Group 2: Fruits and vegetables, 0 to 2°C (32 to 36°F), 95-100% relative humidity. Many products in this group are sensitive to ethylene.

amaranth*	corn, sweet*	parsley*
anise*	daikon*	parsnips*
artichokes*	endive*	peas*
asparagus	escarole*	pomegranate
bean sprouts	grapes (without sulfur dioxide)	raddichio
beets*	horseradish	radishes*
Belgian endive	Jerusalem artichoke	rhubarb
berries (except cranberries)	kiwifruit	rutabagas*
bok choy	kohlrabi*	salsify
broccoli*	leafy greens	scorzonera
brussels sprouts*	leeks* (not with figs or grapes)	snow peas
cabbage*	lettuce	spinach*
carrots*	lo bok	turnips*
cauliflower	mushrooms	waterchestnut
celeriac*	onions, green* (not with figs, grapes, mushrooms, rhubarb, or corn)	watercress*
celery*		
cherries		

*these products can be top-iced.

Group 3: Fruits and vegetables, 0 to 2°C (32 to 36°F), 65-75% relative humidity. Moisture will damage these products.

garlic	onions, dry
--------	-------------

Group 4: Fruits and vegetables, 4.5°C (40°F), 90-95% relative humidity.

cactus leaves	lemons*	tamarillo
cactus pears	lychees	tangelos*
caimito	kumquat	tangerines*
cantaloupes**	mandarin*	ugli fruit*
clementine	oranges*(Calif. and Arizona)	yucca root
cranberries	pepino	

*citrus treated with biphenyl may give odors to other products.

**can be top-iced.

Table 4: Compatability groups—Continued

Group 5: Fruits and vegetables, 10°C (50°F), 85-90% relative humidity. Many of these products are sensitive to ethylene. These products also are sensitive to chilling injury.

beans	kiwano	pummelo
calamondin	malanga	squash, summer (soft shell)
chayote	okra	tamarind
cucumber	olive	taro root
eggplant	peppers	
haricot vert	potatoes, storage	

Group 6: Fruits and vegetables, 13 to 15°C (55 to 60°F), 85-90% relative humidity. Many of these products produce ethylene. These products also are sensitive to chilling injury.

atemoya	granadilla	papayas
avocados	grapefruit	passionfruit
babaco	guava	pineapple
bananas	jaboticaba	plantain
bitter melon	jackfruit	potatoes, new
black sapote	langsat	pumpkin
boniato	lemons*	rambutan
breadfruit	limes*	santol
canistel	mamey	soursop
carambola	mangoes	sugar apple
cherimoya	mangosteen	squash, winter (hard shell)
coconuts	melons (except cantaloupes)	tomatillos
fejjoa		tomatoes, ripe
ginger root		

*citrus treated with biphenyl may give odors to other products.

Group 7: Fruits and vegetables, 18 to 21°C (65 to 70°F), 85-90% relative humidity.

jicama	sweetpotatoes*	watermelon*
pears (for ripening)	tomatoes, mature green	white sapote yams*

*separate from pears and tomatoes due to ethylene sensivity.

Group 8: Flowers and florist greens, 0 to 2°C (32 to 36°F), 90-95% relative humidity.

allium	freesia	peony, tight buds
aster, China	gardenia	ranunculus
bouvardia	hyacinth	rose
carnation	iris, bulbous	squill
chrysanthemum	lily	sweet pea
crocus	lily-of-the-valley	tulip
cymbidium orchid	narcissus	
adiantum (maidenhair)	ground pine	rhododendren
cedar	ilex (holly)	salal (lemon leaf)
dagger and wood	juniper	vaccinium (huckleberry)
ferns	mistletoe	
galax	mountain-laurel	
woodwardia fern		

Table 4: Compatability groups—Continued

Group 9: Flowers and florist greens, 4.5°C (40°F), 90-95% relative humidity.

acacia	delphinium	orchid,
alstromeria	feverfew	cymbidium
anemone	forget-me-not	ornithogalum
aster, China	foxglove	poppy
buddleia	gaillardia	phlox
calendula	gerbera	primrose
calla	gladiolus	protea
candytuft	gloriosa	ranunculus
clarkia	gypsophilla	snapdragon
columbine	heather	snowdrop
coreopsis	laceflower	statice
cornflower	lilac, forced	stephanotis
cosmos	lupine	stevia
dahlia	marigolds	stock
daisies	mignonette	strawflower
violet	zinnia	
adiantum (maidenhair)	eucalyptus	myrtus (myrtle)
asparagus (plumosa, sprenger)	hedera	philodendren
buxus (boxwood)	ilex (holly)	pittosporum
camellia	leatherleaf (baker fern)	pothos
croton	leucothoe, drooping	scotch-broomern
dracaena	magnolia	smilax, southern
		woodwardia fern

Group 10: Flowers and florist greens, 7 to 10°C (45 to 50°F), 90-95% relative humidity.

anemone	eucharis	orchid, cattleya
bird-of-paradise	gloriosa	sweet william
camellia	godetia	
chamaedora	cordyline (ti)	palm
	podocarpus	

Group 11: Flowers and florist greens, 13 to 15°C (55 to 60°F), 90-95% relative humidity.

anthurium	heliconia	poinsetta
ginger	orchid, vanda	
differbachia	staghorn fern	

Chill Sensitivity

Most tropical products are subject to chilling injury when transported or stored at lower than recommended temperatures. This damage often becomes apparent after the products warm up. Products injured may show pitting, discoloration, water soaked areas, decay, and failure to ripen. The following Table 5 lists tropical and other products that sensitive to this injury.

Table 5: Products sensitive to chilling injury

atemoya	guavas	plantain
avocados	haricot vert	pomegranates
babaco	jaboticaba	potatoes
bananas	jackfruit	potted plants
beans	jicama	pummelo
bitter melon	kiwano	pumpkins
black sapote	langsat	rambutan
boniato	lemons	santol
breadfruit	limes	sapodilla
calabaza	malanga	soursop
calamondin	mamey	squash
canistel	mangoes	sugar apple
cantaloupe	mangosteen	sweet potatoes
carambola	melons	tamarillo
chayote	okra	tamarind
cherimoya	olive	taro root
cranberries	oranges (California and Arizona)	tomatillo
cucumbers	papaya	tomatoes
custard apple	passionfruit	tropical flowers
eggplant	pepino	ugli fruit
feijoa	peppers	watermelon
ginger root	pineapples	white sapote
granadilla		yam
grapefruit		

Freeze Sensitivity

Many products are recommended to be transported or stored at temperatures only 1° to 3°C (2-6°F) above their freezing points. Thermostats, however, on some trailers and van containers are set 1° to 3°C (2-6°F) higher than the recommended temperature of 0°C (32°F) for chilled products to avoid freezing. The following Table 6 lists a small number of products according to their sensitivity to freezing. Most tropical products are damaged by chilling injury before they freeze.

Moisture Loss Sensitivity

Most products need to be transported and stored at a high relative humidity. Some products are more susceptible to moisture loss than others. Moisture loss results in wilting and shriveling. To reduce moisture loss, products must be adequately precooled before transit. Some products also are waxed, film-wrapped, package-iced, or top-iced.

Relative humidity during transit and storage must be maintained as much as possible. Table 7 lists products by their moisture loss rate in storage.

Table 6: Products susceptible to freezing injury¹

Most susceptible:

apricots lettuce
 asparagus limes
 avocados okra
 bananas peaches
 beans, snap peppers, sweet
 berries (except plums
 cranberries) potatoes
 cucumbers squash, summer
 eggplant sweetpotatoes
 lemons tomatoes

Moderately susceptible:

apples onions (dry)
 broccoli oranges
 sprouting parsley
 cabbage, new pears
 carrots w/o tops peas
 cauliflower radishes, w/o tops
 celery spinach
 cranberries squash, winter
 grapefruit
 grapes

Least susceptible:

beets w/o tops
 brussels sprouts
 cabbage,
 mature or savory
 dates
 kale
 kohlrabi
 parsnips
 rutabagas
 salsify
 turnips w/o tops

The most susceptible products will be injured by one light freezing, moderately susceptible products will recover from one or two light freezings, while least susceptible products can be lightly frozen several times. Fresh products that are lightly frozen should not be handled. Thawing should be done at 4°C (40°F).

¹Source: Hardenburg, Watada, and Wang (7).

Table 7: Moisture loss rate of products¹

High Loss Rate:

apricots
 blackberries
 broccoli*
 cantaloupes*
 chard*
 cherries
 Chinese vegetables
 figs
 grapes
 green onions*
 guavas
 kohlrabi
 leafy greens*
 lychees
 mangoes
 mushrooms
 papayas
 parsley*
 peaches
 persimmons
 pineapples
 plums and prunes
 raspberries
 strawberries
 cut flowers
 vegetables with tops*

Medium Loss Rate:

avocados
 artichokes*
 asparagus
 bananas
 beets*
 brussels sprouts*
 cabbage*
 carrots, topped*
 cauliflower,
 unwrapped
 celeriac*
 celery*
 coconuts
 corn, sweet*
 cranberries
 endive*
 escarole*
 grapefruit
 green beans
 leeks*
 lemons
 lettuce
 limes
 nectarines
 okra
 oranges

Medium Loss Rate:

parsnips*
 pears
 peas
 peppers
 pomegranates
 quinces
 radishes*
 rhubarb
 rutabagas*
 sweet potatoes
 squash, summer
 (soft shell)
 tangerines
 tomatoes
 yams

Low Loss Rate

apples
 cauliflower, wrapped
 cucumbers, waxed
 eggplant
 garlic
 ginger root
 kiwifruit
 melons
 onions, dry
 potatoes
 pumpkins
 squash, winter
 (hard shell)

* can be top-iced.

¹Source: largely from Safeway Stores, Inc. (25)

Ethylene Sensitivity

Never transport or store fruits and vegetables that produce a lot of ethylene with products that are sensitive to it. Ethylene can cause premature ripening of some products and will ruin others, such as plants and cut flowers. Cucumbers and celery turn yellow in the presence of ethylene, while lettuce will turn brown. Potassium permanganate pads can be used to absorb ethylene during transit and storage. Table 8 lists products that produce ethylene along with products that are sensitive to it.

Table 8: Products that are ethylene producers or ethylene sensitive

Ethylene producers:		Ethylene sensitive:	
apples	mangosteen	bananas, unripe	leafy greens
apricots	nectarines	Belgian endive	lettuce
avocados	papayas	broccoli	okra
bananas, ripening	passionfruit	brussels sprouts	parsley
cantaloupes	peaches	cabbage	peas
cherimoya	pears	carrots	peppers
figs	persimmons	cauliflower	potted plants
guavas	plantains	chard	spinach
honeydew melons	plums	cucumbers	squash
kiwifruit, ripe	prunes	cut flowers	sweetpotatoes
mamey	quinces	eggplant	watercress
mangoes	rambutan	florist greens	watermelon
	tomatoes	green beans	yams
		kiwifruit, unripe	

Odor Sensitivity

Never transport or store odorous products with products that will absorb the odors. Table 9 lists products that produce odors with products that can absorb them.

Table 9: Products which produce or absorb odors

Odor produced by:	Will be absorbed by:
apples	cabbage, carrots, celery, figs, onions, meat, eggs, dairy products
avocados	pineapples
carrots	celery
citrus fruit	meat, eggs, dairy products
ginger root	eggplant
grapes fumigated w/ sulfur dioxide	other fruits and vegetables
leeks	figs, grapes
onions, dry	apples, celery, pears
onions, green	corn, figs, grapes, mushrooms, rhubarb
pears	cabbage, carrots, celery, onions, potatoes
potatoes	apples, pears
peppers, green	pineapples
"strongly scented" vegetables	citrus fruit

Receiving Procedures

Before completely unloading a shipment for storage, receivers should check the load to determine if it meets specifications for quality, grade, and packaging. The receiver also should note whether the load was adequately braced and the correct temperature was maintained.

Product temperatures in sample shipping containers throughout the load should be taken and recorded, using an electronic probe thermometer. The air temperature recorder should be read if one was placed in the load. Shippers and carriers should be notified of any problems with the product, packaging, loading method, or transportation equipment, so corrective action can be taken.

If there is a problem with the load, the receiver, carrier, or shipper can request an inspection by a licensed federal or federal/state inspector. Unresolved disputes over product quality or payment can be referred to the Perishable Agricultural Commodities Act (PACA) Branch of AMS. Further information is given in Appendix 1.

Unloaded products need to be protected from direct sun, condensation, ethylene produced by equipment exhaust and other products, and contamination. Products needing refrigeration or protection from hot or cold temperatures should be placed in the recommended storage conditions as soon as possible. Otherwise, the efforts of growers, shippers, and carriers to maintain product quality will have been in vain.

Air Circulation and Sanitation

Uniform air circulation in the storage room at the proper temperature and relative humidity is important to remove product heat from respiration and outside heat entering through door openings and building surfaces. Doors to refrigerated storage areas should be protected with plastic strip curtains to reduce heat gain during operations. Warm air will quickly reduce relative humidity in the cold storage area.

To maintain temperature and relative humidity, the storage room refrigeration system should have a large evaporator surface area, an adequate number of fans, and a humidifier. Temperature control should be by an electronic thermostat. The system must be carefully balanced to avoid free moisture or excessive air flow.

Electric forklifts and pallet jacks should be used as they do not produce ethylene. Periodic sanitation of the storage room walls, ceilings, floor, and refrigeration units is necessary to reduce decay organisms and odors. Carbon filters can be used to absorb odors and volatile gases, while potassium permanganate pads can be used to absorb ethylene.

Tropical and Subtropical Fruits and Vegetables, and Specialty Products

Many products that are familiar to consumers such as asparagus, bell peppers, eggplant, grapefruit, melons, oranges, sweet corn, and tomatoes, are either tropical in origin or cultivated in areas with tropical and subtropical climates; in addition to areas with temperate climates. These products are included in this book along with many specialty products due to their economic importance and consumer demand for a year-round supply.

Many tropical fruits and vegetables are considered specialty products in the trade due to limited consumer awareness outside of the Asian and Hispanic communities. Shippers, retailers, and trade organizations are increasing demand by providing recipes and handling information for the consumer. Small illustrated brochures are placed in shipping containers of products for distribution in the food stores. Video tapes and posters also are displayed in the stores. Advertisements, articles, and features are placed in magazines, newspapers, and on television.

More research needs to be done on handling, packaging, and transporting many of these items, especially in the areas of postharvest treatments, precooling, and sensitivity to chilling, freezing, moisture loss, ethylene, odors, bruising, and decay. For each product covered in this section, the available information¹ is categorized as follows:

Names: Common names and the scientific name of the fruit or vegetable are given to assist the reader in identification and further research of each product. Names often vary by country and region and there is disagreement over the "correct" common name for many products.

Availability: The time of year products are harvested in the United States and foreign countries is given. Not all sources of a product are listed. Due to USDA requirements, some of these products are not permitted to enter the United States from certain countries until effective quarantine treatments for destructive insects or diseases are developed. Permits are subject to change as treatments are developed or as new pest and disease problems arise. A permit from APHIS in the name of the U.S. importer is needed for almost all plant products entering the United States. The permit may require the product undergo treatment prior to entry. Entry may be restricted to certain ports in the United States.

Grades: In lieu of official or industry grades, descriptions of size and appearance are given. Some products such as pineapple are harvested fully ripe, as the ripening process will not continue after they are picked. International tropical grading standards are under discussion. U.S. inspection instructions will soon be available for many specialty items.

Treatments: Postharvest treatments are mentioned. These treatments must meet the regulations of the importing country. Growers, shippers, and importers should check with APHIS for the status of chemical or cold temperature quarantine treatments for insects and diseases. Treatments are required based on the type of product, source of the product, type of insect or disease, and port of entry.

Precooling: A method is recommended based on the nature of the product. Many products can be cooled by more than one method.

Temperature & Relative Humidity: The recommended product temperature and relative humidity to be achieved in precooling, transit and storage, to maintain quality, are given. When transporting chilled products, however, some carriers recommend setting the thermostat 1-3°C (2-6°F) higher than the recommended temperature of 0°C (32°F) to avoid freezing injury. Table 10 at the end of this section summarizes the recommended temperature, relative humidity, and approximate transit and storage period for the fruits and vegetables covered in this handbook. Information also is given for other fruits and vegetables.

Sensitivity: The sensitivity of the product to chilling injury, freezing injury, moisture loss, ethylene damage, odors, bruising, or decay is highlighted. Many tropical fruits and vegetables are highly perishable.

Transit & Storage Life: The time available for transit and storage is estimated for products that are properly packaged and held as close as possible at the recommended product temperature and relative humidity. Many tropical fruits and vegetables are held at room temperature at the retail store and in the consumers home for ripening. Bananas are ripened before retail display as are some avocados, kiwifruit, and tomatoes.

Packaging: Common package sizes used are listed with approximate weights. Otherwise, a recommendation is made. Standardized or MUM containers, however, should be used when possible. Many tropical fruits and vegetables are low volume items and can be packaged in 4.5 kg (10 lb) quantities to minimize waste and increase flexibility in sales. Highly perishable items must be well protected.

Transportation: Based on the transit and storage life, a recommendation is made. Since many tropical products are high-value and traded in small quantities, they are often shipped by air, even when surface transportation could be used.

Loading: Any special loading considerations or methods are mentioned.

Notwithstanding the information presented in this section, shippers should follow the recommendations of the importer for grade, weight, count, type of packaging and method of transportation for tropical fruits and vegetables, and other specialties. A number of firms in the United States specialize in handling these items. They can give the best information for selling to a particular market.

¹Sources of information for the following product guidelines are: Buishand, Houwing, and Jansen (3), Hardenburg, Watada, and Wang (7), Martin (11), Maxwell and Maxwell (12),(13), Ortho Books (15), Pantastico (17), Pijpers, Constant, and Jansen (18), The Packer (16), Produce Marketing Association (20), United Fresh Fruit and Vegetable Association (28). Information also was obtained from APHIS, J.R. Brooks & Son, Inc. and Freida's Finest Produce Specialties, Inc.

Amaranth (*Amaranthus dubius*)

Availability: year-round, California, West Indies.

Grade: dark green leaves, handled like spinach.

Precooling: hydrocool, package-ice.

Temperature & Relative Humidity: 0-2°C (32-36°F) 95-100%.

Sensitivity: freezing injury.

Transit & Storage Life: 10-14 days.

Packaging: waxed fiberboard boxes, wirebound wood crates, 9 kg (20 lb).

Transportation: highway and piggyback trailers, van containers.

Anise (*Pimpinella anisum*)

Availability: year-round, California, Puerto Rico.

Grade: U.S. No. 1.

Precooling: hydrocool, package-ice.

Temperature & Relative Humidity: 0° to 2°C (32-36°F), 90-95%.

Sensitivity: freezing injury.

Transit & Storage Life: 2-3 weeks.

Packaging: one-piece waxed fiberboard box or nailed wood crate, 1-1/2, 2, 2-1/2, or 3 dozen count, 18-23 kg (40-50 lb).

Transportation: highway and piggyback trailers, van containers.

Artichoke, Globe (*Cynara scolymus*)

Availability: year-round, California, peak season March-May; Chile Grades: U.S. No. 1 and No. 2.

Precooling: hydrocool

Temperature & Relative Humidity: 0°C (32°F), 95-100%.

Sensitivity: freezing below -1°C (30°F); moisture loss; bruising.

Transit & Storage Life: 2-3 weeks.

Packaging: place-packed by size and count in waxed fiberboard boxes, 10 kg (22 lb.): 18 jumbos, 24 extra large, 36 large, 48 medium, 60 or 72 small. Baby artichokes, small or large, are packed loose, 70-120 count. Perforated film liners will help maintain humidity in packaging.

Transportation: highway and piggyback trailers, van containers, early season and some imports by air cargo containers.

Loading: hand-loaded or palletized. Top-ice in trailers.

Asian Pear (Apple pear, Sandpear, *Pyrus pyrifolia*)

Availability: August-October, depending on variety, California, Washington; Japan; New Zealand.

Grade: round like an apple, green, yellow, or yellowish green skin when ripe, depending on variety.

Precooling: room cool.

Temperature & Relative Humidity: 1°C (34°F), 90-95%.

Sensitivity: freezing injury, moisture loss; ethylene producer.

Transit & Storage Life: 5-6 months:

Packaging: film lined full telescoping fiberboard box, tray pack, 10 kg (22 lb).

Transportation: highway and piggyback trailers, van containers.

Asparagus (*Asparagus officinalis*)

Availability: California, Washington, New Jersey and several other States, Mexico, Canada, Chile, Guatemala, New Zealand, Australia, the Caribbean.

Grade: U.S. No. 1 & No.2; Washington Extra Fancy and Fancy jumbo, large or standard; New Jersey 1. Top quality asparagus is straight, 1/2 inch maximum diameter, and at least two thirds green.

Precooling: hydrocool.

Temperature & Relative Humidity: 0-2°C (32-36°F), 95-100%.

Sensitivity: freezing injury at -1°C (30°F); moisture loss.

Transit & Storage Life: 2-3 weeks

Packaging: nailed wood pyramid crates, waxed fiberboard or corrugated plastic pyramid boxes, rectangular waxed fiberboard boxes, loose pack crates contain 14.5 kg (32 lb); 1/2 crates—6-7.7 kg (13-17 lb); boxes—16 bunches, 0.7 kg (1.5 lb) each, totaling 11 kg (25 lb); crates—12 bunches yielding 13.6 kg (30 lb); Bunches are secured with rubber bands or plastic film sleeves with labels. A foam moisture pad is placed in the bottom of boxes and crates to reduce wilting.

Transportation: highway and piggyback trailers, van containers, general cargo vessels, some early season and imports by air cargo containers.

Loading: hand-loaded or palletized. Wood crates are cross-stacked.

Atemoya (*Annona squamosa* x *A. cherimola*, hybrid)

Availability: August-October, Florida.

Grade: heart shaped light green fruit with scales, 89-140 mm (3.5-5.5 in), weighing 284-454 g (10-16 oz).

Precooling: forced air, room cool.

Temperature & Relative Humidity: 13°C (55°F), 85-90%.

Sensitivity: chilling injury; bruising.

Transit & Storage Life: 4-6 weeks.

Packaging: single layer pack in fiberboard box with paper or foam wrapping or excelsior to reduce bruising. 4.5 kg (10 lb).

Transportation: highway trailers, air cargo containers.

Avocados—Fuerte, Hass, Booth-7 varieties (*Persea spp.*)

Availability: year-round, California with peak supplies in Spring; Florida from August-December with peak supplies in October; Chile, West Indies.

Grade: U.S. No. 1, Combination, No. 2, No. 3; California regulations.

Treatments: controlled ripening with ethylene.

Precooling: forced air.

Temperature & Relative Humidity: 7°C (45°F) 85-90%.

Sensitivity: chilling injury at or below 4°C (39°F); ethylene producer.

Transit & Storage Life: 2 weeks.

Packaging: two layer tray-packed Bliss boxes and lugs, 11-13 kg. (25-28 lbs); single layer, tray-packed Bliss carton, 5.6 kg (12.5 lbs); single layer cartons 6 kg (13-13.5 lbs).

Transportation: highway and piggyback trailers, van containers, some imports by air cargo containers.

Loading: palletized unit loads with cornerboards and strapping.

Avocados—Lula, Booth 1, Booth 3, Taylor, Hickson, Hall Varieties (*Persea spp.*)

Availability: August-December, Florida with peak supplies in October; West Indies.

Grade: U.S. No. 1, Combination, No. 2, No. 3.

Treatments: controlled ripening with ethylene.

Precooling: forced air.

Temperature & Relative Humidity: 4°C (39°F) 90-95%.

Sensitivity: chilling injury below 4°C (39°F); ethylene producer.

Transit & Storage Life: 4-8 weeks.

Packaging: two layer tray-packed Bliss boxes and lugs, 11-13 kg. (25-28 lbs); single layer, tray-packed Bliss carton, 5.6 kg (12.5 lbs); single layer cartons 6 kg (13-13.5 lbs).

Transportation: highway and piggyback trailers, van containers, some imports by air cargo containers.

Loading: palletized unit loads with cornerboards and strapping.

Avocados—Fuchs, Pollock, Waldin Varieties (*Persea spp.*)

Availability: August-December, Florida with peak supplies in October; West Indies.

Grade: U.S. No. 1, Combination, No. 2, No. 3.

Treatments: controlled ripening with ethylene.

Precooling: forced air.

Temperature & Relative Humidity: 13°C (55°F) 85-90%.

Sensitivity: chilling injury below 7°C (45°F); ethylene producer.

Transit & Storage Life: 2 weeks.

Packaging: two layer tray-packed Bliss boxes and lugs, 11-13 kg (25-28 lbs); single layer, tray-packed Bliss carton, 5.6 kg (12.5 lbs); single layer cartons 6 kg (13-13.5 lbs).

Transportation: highway and piggyback trailers, van containers, some imports by air cargo containers.

Loading: palletized unit loads with cornerboards and strapping.

Babaco (*Carica pentagona*)

Availability: year-round; November-January, New Zealand.

Grade: shipped green, soft golden when fully ripe, 280-400 mm (11-16 in) long.

Precooling: hydrocool, forced air.

Temperature & Relative Humidity: 7°C (45°F), 85-90%.

Sensitivity: chilling injury below 7°C.

Transit & Storage Life: 1-3 weeks.

Packaging: tray pack in fiberboard cartons with paper excelsior.

Transportation: van containers, air cargo containers.

Baby Vegetables—artichokes, avocados, beets (gold, red), carrots, cauliflower, celery, corn, eggplant (black, white), leeks, lettuce, kohlrabi, pear tomatoes, pearl onions (purple, red, yellow), scallopini, squash, some with blossoms (acorn, courgette-fluer, crookneck, custard marrow or patty pan, lemon drop, royal opal, sunburst, zucchini), turnips (gold, white).

Availability: artichokes, March-May; celery, lettuce, September-March; corn, eggplant, pear tomatoes, scallopini, squash, May-October; avocados, beets, carrots, turnips, year-round; California, Florida, Guatemala, France.

Grade: These items are for the restaurant/gourmet cooking trade, quality must be very high.

Precooling: hydrocool artichokes, beets, carrots, cauliflower, celery, corn, leeks, kohlrabi, turnips. Vacuum cool celery and lettuce. Forced air cool avocados, eggplant, onions, squash, and tomatoes. Package-ice bunched beets, carrots, kohlrabi, leeks, and turnips.

Temperature & Relative Humidity: 0°C (32°F), 95-100% artichokes, avocados, beets, carrots, cauliflower, celery, corn, leeks, lettuce, kohlrabi, onions and turnips. 13°C (55°F), 90-95% avocados, eggplant, and squash.

Sensitivity: these products are more perishable in terms of bruising, chilling injury, freezing injury, moisture loss, ethylene damage, and odors.

Transit & Storage Life: as little as 1 week, especially for products with their tops or blossoms intact.

Packaging: waxed fiberboard boxes, holes for ventilation. Artichokes, 120 count; avocados, 4.5 kg (10 lb); bunched beets, 24 count; bunched carrots, 24 count; cauliflower, 24 count; corn, 48 count; eggplant, 4.5 kg (10 lb); bunched kohlrabi, 24 count; bunched leeks, 24 count; lettuce, 24 count; pearl onions, 12—284 g (10 oz) packages, scallopini, 4.5 kg (10 lb); squash, 4.5 kg (10 lb), bunched turnips, 24 count.

Transportation: highway and piggyback trailers, air cargo containers.

Loading: products are often shipped in mixed pallet loads.

Bananas (*Musa spp.*)

Availability: year-round, Hawaii, Ecuador, Honduras, Costa Rica, Columbia, Panama, Guatemala, Mexico, West Indies.

Grade: Industry grades No. 1 and No. 2.; shipped green, color and size are measured in the field prior to harvest.

Treatments: ethylene in ripening rooms at 14° to 18° C (58-65° F).

Precooling: forced air, room.

Temperature & Relative Humidity: 13° to 14°C (55-58°F) 90-95%.

Sensitivity: chilling injury below 13°C (55°F); bruising; ethylene producer/ethylene sensitive.

Transit & Storage Life: 1-4 weeks.

Packaging: film-lined full telescoping fiberboard boxes, 18 kg (40 lb). The liner is sealed by some shippers to obtain a modified atmosphere and delay ripening.

Transportation: highway and piggyback trailers, van containers, breakbulk vessels.

Loading: palletized with netting or hand loaded.

Barbados Cherry (*Acerola*, West Indies Cherry, *Malpighia glabra*)

Availability: April-November, Florida.

Grade: bright red, 25 mm (1 in) dia, yellow-orange flesh when ripe, ship only half ripe fruit.

Precooling: forced air.

Temperature & Relative Humidity: 0°C (32°F), 85-90%.

Sensitivity: freeze damage at -1° C (30° F), ripe fruit bruises easily.

Transit & Storage Life: 7-8 weeks.

Packaging: one piece fiberboard boxes, 5-9 kg (12-20 lb).

Transportation: highway and piggyback trailers, van containers.

Bean Sprouts (*Mung bean*, *Vigna radiata* or Soybean, *Glycine max*)

Availability: year-round, United States.

Grade: firm sprouts.

Precooling: hydrocool.

Temperature & Relative Humidity: 0°C (32°F) 95-100%.

Sensitivity: freezing injury.

Transit & Storage Life: 7-9 days.

Packaging: consumer packs in fiberboard boxes, film bags: 227 g (8 oz), 12 count; 0.5 kg (1 lb), 10 count; 2 kg (5 lb); 4.5 kg (10 lb).

Transportation: highway and piggyback trailers, van containers.

Beans, Green or Snap (*Phaseolus vulgaris*)

Availability: year-round, Florida, October-June; many other States ship during the summer; Mexico, Canada.

Grade: U.S. Fancy, No. 1, Combination, No. 2.

Precooling: vacuum or forced air. High respiration rate.

Temperature & Relative Humidity: 4 to 7°C (40-45°F), 95%.

Sensitivity: chilling injury below 4°C (40°F), decay from moisture if held above 7°C (45°F); ethylene sensitive.

Transit & Storage Life: 7-10 days.

Packaging: wirebound wood crates, 0.035 cu m (1 bu), 12-14 kg (26-31 lb); partially telescoping fiberboard boxes, 11-14 kg (25-30 lbs) and 9-10 kg (20-22 lbs).

Transportation: highway and piggyback trailer.

Loading: hand loaded or palletized, with provisions for air circulation throughout when the beans are in crates or boxes.

Beans, Lima (*Phaseolus lunatus*)

Availability: year-round, peaking in July-October, California and many other States.

Grade: U.S. Fancy, No. 1, Combination, No. 2.

Precooling: vacuum or forced air. High respiration rate.

Temperature & Relative Humidity: 5° to 6°C (41-43°F), 95% (unshelled).

Sensitivity: chilling injury below 5°C (41°F); decay at higher temperatures; ethylene sensitive.

Transit & Storage Life: 5 days.

Packaging: wirebound wood crates, 0.035 cu m (1 bu), 12-14 kg (26-31 lb); partially telescoping fiberboard boxes, 11-14 kg (25-30 lbs) and 9-10 kg (20-22 lbs).

Transportation: highway and piggyback trailer.

Loading: hand-loaded or palletized, with provisions for air circulation throughout when the beans are in crates or boxes.

Belgian Endive (Witloof Chicory, *Cichorium intybus*, var. *foliosum*)

Availability: year-round, New York, Belgium, France, The Netherlands.

Grade: bullet shaped heads, 100-165 mm (4-6.5 in) long, peel outer green leaves before packing.

Precooling: vacuum cool.

Temperature & Relative Humidity: 2° to 3°C (36-37°F), 95-98%.

Sensitivity: freezing injury; bruising; light will cause leaves to turn green and bitter; ethylene sensitive.

Transit & Storage Life: 2-4 weeks.

Packaging: film-lined full telescoping fiberboard boxes or masonite and wood crates with telescoping fiberboard top, 4.5 kg (10 lb) with 48-56 count.

Each layer is protected from light and moisture loss with dark blue paraffin paper wrapping.

Transportation: highway and piggyback trailers, van containers, air cargo containers.

Loading: Two boxes are tied together, units are palletized with film wrap or cornerboards and strapping.

Bitter Melon (Balsam pear, Bitter gourd, *Momordica charantia*)

Availability: year-round, California, Puerto Rico.

Grade: wrinkled green skin, up to 340 mm (13 in) long.

Precooling: hydrocool, forced air.

Temperature & Relative Humidity: 12° to 13°C (54-55°F) 85-90%.

Sensitivity: chilling injury.

Transit & Storage Life: 2-3 weeks.

Packaging: full telescoping fiberboard boxes and wood wirebound crates, wood lugs, 9 kg (20 lb), 18 kg (40 lb).

Transportation: highway and piggyback trailers, van containers.

Black Sapote (*Diospyros ebenaster*)

Availability: December-April, Florida.

Grade: dull olive green fruit, 60-120 mm (2.5-4.5 in) diameter, shipped unripe.

Precooling: forced air, room cool.

Temperature & Relative Humidity: 13 to 15°C (55-60°F), 85-90%.

Sensitivity: chilling injury.

Transit & Storage Life: 2-3 weeks.

Packaging: single layer pack in fiberboard box, with wrap or sleeves to limit bruising, 4.5 kg (10 lb).

Transportation: highway and piggyback trailers, van containers, air cargo containers.

Blood Orange (*Citrus sinensis*)

Availability: November-March, Italy; March-April, California.

Grade: pink or red pulp, pink blush on rind, 76 mm (3 in) diameter.

Precooling: forced air, room cool.

Temperature & Relative Humidity: 4° to 7°C (39-45°F), 90-95%.

Sensitivity: chilling injury below 3°C (38°F).

Transit & Storage Life: 3-8 weeks.

Packaging: full telescoping fiberboard box, 1/2 bu bushel, 14 kg (30 lb), 4/5 bushel, 20 kg (45 lb), place pack, 18 kg (40 lb).

Transportation: highway and piggyback trailers, van containers.

Loading: palletized or cross stacked on slip sheets.

Bok Choy (Pak-choi, celery cabbage, *Brassica rapa*, var, *chinesis*)

Availability: year-round, California, Florida, New York.

Grade: white stalks, green leaves, 300 mm (12 in) long.

Precooling: vacuum cool, hydrocool, package-ice.

Temperature & Relative Humidity: 0°C (32°F), 95-100%.

Sensitivity: freezing below 0°C (32°F); ethylene.

Transit & Storage Life: 3 weeks.

Packaging: bunched, Western Growers Association nailed wood crates, lined with paper, 29-32 kg (65-70 lb); 1/2 wood crate, 14-18 kg (30-40 lb).; 368 mm (14.5 in) wirebound wood crates, 20-25 kg (45-54 lb) 390 mm (15.5 in) wirebound wood crates, 23 kg (50 lb); 0.052 cu m (1.5 bushel) wirebound crates 23-24 kg (50-53 lb).

Transportation: highway and piggyback trailers, van containers.

Loading: hand-loaded or palletized.

Boniato (Batas, Aerial yam, *Dioscorea bulbifera*)

Availability: year-round, Florida, Puerto Rico.

Grade: red skinned yam with white flesh.

Treatments: washed and treated with fungicide.

Precooling: room cooling, forced air.

Temperature & Relative Humidity: 13° to 15°C (55-60°F), 85-90%.

Sensitivity: chilling injury below 12°C (54°F).

Transit & Storage Life: 4-5 months.

Packaging: full telescoping fiberboard boxes and wirebound crates, 23 kg (50 lb).

Transportation: highway and piggyback trailers, van containers.

Breadfruit (Panapen, *Artocarpus altlis*)

Availability: year-round, Florida, Puerto Rico, West Indies, Belize.

Grade: harvested at all stages—immature, mature green, and yellow-green ripe with brown speckles. Seeds are processed, sold as breadnuts, knobby skin, 100-300 mm (4-12 in) diameter.

Precooling: forced air, room cool.

Temperature & Relative Humidity: 13 to 15°C (55-60°F) 85-90%.

Sensitivity: chilling injury below 12°C (54°F), ethylene sensitive.

Transit & Storage Life: 2-6 weeks.

Packaging: full telescoping fiberboard box, film wrap, 7 kg (15 lb), 18 kg (40 lb).

Transportation: highway and piggyback trailers, van containers, air cargo containers.

Broccoli (*Brassica oleracea*, *Botrytis* group)

Availability: year-round, California, Texas, Oregon, Arizona, Mexico, Canada, Guatemala.

Grade: U.S. Fancy, No. 1, and No. 2.

Precooling: hydrocool, package-ice.

Temperature & Relative Humidity: 0°C (32°F), 95-100%.

Sensitivity: very high respiration rate and moisture loss; ethylene will cause yellowing.

Transit & Storage Life: 10-14 days.

Packaging: one-piece wax impregnated fiberboard box, package-iced, 14-18 bunches, 10 kg (23 lb); 4.5 kg (10 lb) bulk florets; 1.4 kg (3 lb) mesh bags of florets; 7 kg (15 lb) 76-102 mm (3-4 in) spears; 9.5 kg (21 lb) 152 mm (6 in) spears.

Transportation: highway and piggyback trailers, van containers.

Loading: top-ice.

Brussels Sprouts (*Brassica oleracea*, *Gemmifera* group)

Availability: year-round, California, Mexico

Grade: U.S. No. 1 and No. 2.

Precooling: hydrocool, forced-air, package-ice.

Temperature & Relative Humidity: 0°C (32°F), 95-100%

Sensitivity: high respiration and moisture loss rate; ethylene will cause yellowing.

Transit & Storage Life: 3-5 weeks.

Packaging: perforated film-lined waxed fiberboard box, 11 kg (25 lb); fiberboard trays with 12 count 284 g or 340 g (10 or 12 oz) film wrapped cups.

Transportation: highway and piggyback trailers, van containers.

Loading: top-ice.

Cactus Leaves (Nopales, Nopallitos, *Opuntia ficus indica*)

Availability: year-round, California, Mexico, Dominican Republic, Italy, Bahamas, Belize, Chile, Haiti.

Grade: crisp, green leaves, 6 mm (.25 in) thick, remove thorns.

Precooling: forced air, room cool.

Temperature & Relative Humidity: 2° to 4°C (36-39°F), 90-95%.

Sensitivity: freezing injury, moisture loss.

Transit & Storage Life: 2-3 weeks.

Packaging: full telescoping waxed fiberboard box or paper lined nailed wood crates, 4.5 kg (10 lb), 9 kg (20 lb).

Transportation: highway and piggyback trailers, van containers.

Cactus Pear (Prickly pear, Tuna, *Opuntia ficus indica*)

Availability: year-round, California, Mexico, Dominican Republic, Italy, Bahamas, Belize, Chile, Haiti.

Grade: oval green fruit, 70-100 mm (2.5-4 in), reddish brown when ripe.

Precooling: forced air, room cool.

Temperature & Relative Humidity: 2° to 4°C (36-39°F), 90-95%.

Sensitivity: chilling injury, moisture loss.

Transit & Storage Life: 3 weeks.

Packaging: full telescoping waxed fiberboard box, tissue wrapped place pack, 45, 50, 60, or 70 count, 8 kg (18 lb).

Transportation: highway and piggyback trailers, freight containers.

Caimito (Star apple, *Chrysophyllum cainito*)

Availability: February-May, Florida.

Grade: green or purple fruit depending on variety, 70-80 mm (2.5 to 3 inch) diameter.

Precooling: hydrocool, forced air.

Temperature & Relative Humidity: 3°C (37°F) 90% .

Sensitivity: chilling injury.

Transit & Storage Life: 3 weeks.

Packaging: tray packed fiberboard box, 4.5 kg (10 lb).

Transportation: highway and piggyback trailers, van containers, air cargo containers.

Calabaza (*Cucurbita pepo*)

Availability: year-round, Florida, New Jersey, Dominican Republic, Costa Rica.

Grade: pumpkin, many colors, shapes, sizes.

Precooling: room cool.

Temperature & Relative Humidity: 10° to 13°C (50-55°F), 50-70%.

Sensitivity: chilling injury at 4°C (40°F); decay at higher humidities.

Transit & Storage Life: 2-3 months.

Packaging: plastic mesh sacks, 23 kg (50 lb), bulk fiberboard or wirebound wood bins, 363 kg (800 lb).

Transportation: highway or piggyback trailers, van containers.

Calamondin (*Citrus microcarpa*)

Availability: year-round, Florida.

Grade: greenish-yellow to orange, 20-30 mm (1 to 1-1/4 in) diameter.

Treatments: waxing, fungicide, ethylene for degreening.

Precooling: room, forced air.

Temperature & Relative Humidity: 9° to 10°C (48-50°F) 90%.

Sensitivity: chilling injury.

Transit & Storage Life: 2 weeks.

Packaging: full telescoping fiberboard boxes, nailed wood crates with paper lining, 0.028 cu m (4/5 bu), 21 kg (47 lb); 0.017 cu m (1/2 bu) 11 kg (25 lb).

Transportation: highway and piggyback trailers, van containers.

Canistel (Egg fruit, Zapote amarillo, Pouteria campechiana)

Availability: year-round, Florida.

Grade: yellow-orange skin fruit, 40-120 mm (1.5-5 in) diameter, top shaped.

Precooling: room cool.

Temperature & Relative Humidity: 13° to 15°C (55-60°F), 85-90%.

Sensitivity: chilling injury.

Transit & Storage Life: 3 weeks.

Packaging: one-piece fiberboard box, wrapped, tray pack, 4.5 kg (10 lb).

Transportation: highway and piggyback trailers, van containers, air cargo containers.

Cantaloupes (*Cucumis melo*)

Availability: year-round, California, Texas, Arizona, Mexico, Dominican Republic, Honduras.

Grade: U.S. Fancy, No. 1, Commercial, No.2.

Treatments: hot water dip to reduce decay.

Precooling: hydrocool, forced-air, package-ice.

Temperature & Relative Humidity: 2-5°C (36-41°F), 95% for less than full ripe (3/4 slip), 0-2°C (32-36°F) full ripe (full slip).

Sensitivity: chilling injury to less than full ripe melons below 2°C; high moisture loss rate; ethylene producer.

Transit & Storage Life: 15 days, less than full ripe, 5-14 days full ripe.

Packaging: 1/2 carton, one-piece waxed fiberboard box or wirebound wood crate, 9, 12, 18, or 23 count, 17-19 kg (38-41 lb); 2/3 carton or wirebound or nailed wood crate, 12, 14, 18, 24, or 30 count, 24-25 kg (53-55 lb); standard crate, 32 kg (70 lb); jumbo crate, 18-45 count, 16-18 kg (36-39 lb).

Transportation: highway and piggyback trailers, van containers.

Loading: top-ice.

Carambola (Star fruit, *Averrhoa carambola*)

Availability: August-February, Florida; Belize.

Grade: firm with shiny skin, ripe fruit has yellow-orange color with brown edges, up to 100 mm (4 in) long, with star shaped cross-section.

Precooling: forced air, room.

Temperature & Relative Humidity: 9 to 10°C (48-50°F), 85-90%.

Sensitivity: chilling injury, moisture loss.

Transit & Storage Life: 3-4 weeks.

Packaging: two-piece waxed fiberboard box with cover, plastic pad on bottom to reduce bruising, 4-4.5 kg (8-10 lb).

Transportation: highway and piggyback trailers, van containers.

Carrots (*Daucus carota*)

Availability: year-round, California, Texas, Arizona, Florida; Canada, Mexico.

Grade: Topped carrots, US. Extra No. 1, No. 1, No. 1 Jumbo, and No. 2; bunched carrots, short-trimmed top carrots, U.S. No. 1, Commercial.

Treatments: prestorage dip to reduce decay.

Precooling: hydrocool, vacuum cool, package-ice.

Temperature & Relative Humidity: 0°C (32°F), 98-100%.

Sensitivity: high moisture loss rate, especially for bunched carrots; ethylene will cause bitterness.

Transit & Storage Life: mature carrots, 7-9 months; bunched carrots, 2 weeks; immature carrots, 4-6 weeks.

Packaging: topped carrots in 0.5 kg (1 lb) film bags in master film bag, 23 kg (50 lb); bunched carrots, package-iced, in one-piece waxed fiberboard box, 2 dozen bunches, 10-12 kg (23-27 lb).

Transportation: highway and piggyback trailers, van containers, railroad boxcars.

Loading: hand-loaded or palletized

Cashew Apple (*Anacardium occidentale*)

Availability: Florida.

Grade: red to yellow color, 100-200 mm (4-8 in) long, nut processed too.

Precooling: forced air.

Temperature & Relative Humidity: 0° to 2°C (32-36°F) 85-90%.

Sensitivity: freezing injury.

Transit & Storage Life: 5 weeks.

Packaging: one-piece fiberboard box, 4.5 kg (10 lb).

Transportation: highway and piggyback trailers, van containers.

Cauliflower (*Brassica oleracea*, *Botrytis* group)

Availability: year-round, California, Oregon, Arizona, Texas, Canada, Mexico, Guatemala.

Grade: U.S. No. 1.

Treatments: chlorinated water to reduce decay, improve color. Heads covered with leaves during growing to prevent yellowing.

Precooling: vacuum cool, hydrocool, hydrovacuum cool.

Temperature & Relative Humidity: 0°C (32°F), 95-98%.

Sensitivity: freezing injury at -1°C (30°F); ethylene sensitive.

Transit & Storage Life: 3-4 weeks.

Packaging: wrapped with perforated film, packed in fiberboard trays, 12-16 heads, 10 kg (23 lb); nailed wood crates, 20-23 kg (45-50 lb).

Transportation: highway and piggyback trailers, van containers.

Loading: fiberboard trays are unitized on pallets, crates are hand-loaded.

Celeriac (Celery root, Apio, *Arraccacia xanthorrhiza*)

Availability: year-round, California, Puerto Rico, Dominican Republic, Venezuela.

Grade: root should be firm with tender flesh, 57-102 mm (2.25 to 4 in) diameter, trim tops and branch roots.

Precooling: hydrocool.

Temperature & Relative Humidity: 0°C (32°F), 97-99%.

Sensitivity: freezing at -1°C (30°F), high moisture loss rate.

Transit & Storage Life: 6-8 months.

Packaging: fiberboard boxes, wirebound wood crates, 0.039 cu m (1-1/9 bu), 16 kg (35 lb). Other sizes used include 0.028 cu m (4/5 bu), 0.017 cu m (1/2 bu), and 0.020 cu m (5/9 bu). Wood crates are also used, 9 kg (20 lb), 16 kg (35 lb).

Transportation: highway and piggyback trailers, van containers.

Celery (*Apium graveolens*)

Availability: year-round, California, Florida, Michigan, Canada, Mexico, Guatemala.

Grade: U.S. Extra No. 1, No. 1, and No. 2.

Precooling: vacuum cool, hydrocool, hydrovacuum cool.

Temperature & Relative Humidity: 0°C (32°F), 98-100%.

Sensitivity: high moisture loss rate; freezing injury at -0.5°C (31°F); ethylene sensitive.

Transit & Storage Life: 2-3 months.

Packaging: one-piece waxed fiberboard box, flat pack, 1-1/2 to 3 dozen, 27-29 kg (60-65 lb), also 368 mm (14.5 in) wirebound crates. Celery hearts in film bags in waxed fiberboard box or paper lined wood crates, 12-18 count, 2-3 stalks per bag, 11-17 kg (24-38 lb).

Transportation: highway and piggyback trailers, van containers.

Loading: palletized or hand-loaded.

Chayote Squash (*Sechium edule*)

Availability: September-May, California, Mexico, Central America, New Zealand.

Grade: wrinkled white or green skin depending on variety, pear shaped, 76-100 mm (3-4 in) long.

Precooling: forced air, room cool.

Temperature & Relative Humidity: 7°C (45°F) 85-90%.

Sensitivity: chilling injury; moisture loss; ethylene sensitive

Transit & Storage Life: 4-6 weeks.

Packaging: fiberboard box with dividers, each piece in a film bag, single layer, 24-30 count, 9 kg (20 lb),

Transportation: highway and piggyback trailers, van containers.

Loading: hand-loaded or unitized on pallets.

Cherimoya (Anon, *Annona cherimola*)

Availability: year-round, California, New Zealand.

Grade: clip stem close to fruit which should be firm and pale green to creamy yellow, 100 mm (4 in) diameter or more, weighing 250-600 g (8.8-21 oz).

Precooling: forced air, room cool.

Temperature & Relative Humidity: 13°C (55°F).

Sensitivity: bruising; chilling injury; ethylene producer.

Transit & Storage Life: 2-4 weeks.

Packaging: single layer pack in fiberboard cartons with paper wrapping, foam sleeves, or excelsior to reduce bruising, 12 count.

Transportation: highway and piggyback trailers, van containers, air cargo containers.

Chinese Broccoli (Kailan, Gui Ion, *Brassica var.*)

Availability: Florida, Dominican Republic.

Grade: yellow flowered, light green leaved stems.

Precooling: hydrocool, package-ice.

Temperature & Relative Humidity: 0°C (32°F) 95-100%.

Sensitivity: freezing injury.

Transit & Storage Life: 10-14 days.

Packaging: wirebound wood crates, waxed fiberboard boxes, 16-18 kg (35-40 lb); crates, boxes, lugs, 11 kg (25 lb).

Transportation: highway and piggyback trailers, air cargo containers.

Loading: top-ice.

Chinese Cabbage (Pe-tsai, Napa, *Brassica campestris, var. pekinensis*)

Availability: year-round, California, Florida, New York, New Jersey.

Grade: short leaved stalks, closed head, yellow-green to dark green leaves, up to 580 mm (23 in) long.

Precooling: vacuum cool, package-ice.

Temperature & Relative Humidity: 0°C (32°F), 95-100%.

Sensitivity: freezing injury; high moisture loss rate.

Transit & Storage Life: 2-3 months.

Packaging: Western Growers Association nailed wood crates, lined with paper, 29-32 kg (65-70 lb); waxed fiberboard boxes or 1/2 wood crate, 14-18 kg (30-40 lb); 368 mm (14.5 in) wirebound wood crates, 20-25 kg (45-54 lb) 390 mm (15.5 in) wirebound wood crates, 23 kg (50 lb); 0.052 cu m (1-1/2 bu) wirebound crates 23-24 kg (50-53 lb).

Transportation: highway and piggyback trailers, van containers.

Chinese Long Bean (Asparagus bean, Cow pea, *Vigna unguiculata* ssp. *sesquipedalis*)

Availability: year-round, California, Mexico, Dominican Republic.

Grade: grey-green pods up to 900 mm (36 in) long, trimmed to 300 mm (12 in).

Precooling: hydrocool.

Temperature & Relative Humidity: 4° to 7°C (39-45°F) 90-95%.

Sensitivity: chilling injury at 3°C (38°F).

Transit & Storage Life: 7-10 days.

Packaging: wirebound wood crates, 16-18 kg (35-40 lb)

Transportation: highway and piggyback trailers, van containers.

Clementine (*Citrus reticulata* cv.)

Availability: November-February, California, Florida, Morocco.

Grade: flattish oval deep orange citrus fruit, 50-75 mm (2-3 in) diameter.

Treatments: degreen with ethylene gas.

Precooling: forced air, room cool.

Temperature & Relative Humidity: 4°C (39°F) 90-95%.

Sensitivity: chilling injury at 1°C (34°F).

Transit & Storage Life: 2-4 weeks.

Packaging: wood lugs, full telescoping fiberboard boxes, 0.017 cu m (1/2 bu), 11 kg (25 lb); 0.028 cu m (4/5 bu), 20 kg (45 lb).

Transportation: highway and piggyback trailers, van containers.

Loading: palletized or on slipsheets.

Coconut (*Cocos nucifera*)

Availability: year-round, Puerto Rico, Honduras, Dominican Republic Jamaica.

Grade: Puerto Rico No. 1 and No. 2.

Treatments: wax coating or film wrap to prevent moisture loss.

Precooling: hydrocool, forced air.

Temperature & Relative Humidity: 0 to 1.5°C (32-35°F) 80-85% for long term transit and storage, 13° to 16°C (55-60°F) 80-85% for 2 weeks or less.

Sensitivity: moisture loss; freezing at 3°C (26°F), a rapid temperature change of 8°C (15°F) will cause cracking.

Transit & Storage Life: 1-2 months, (2 weeks at room temperature).

Packaging: woven plastic or burlap sacks, 40-50 count, 34-36 kg (75-80 lb), full telescoping fiberboard boxes, 20-25 count, 17-18 kg (37-40 lb).

Transportation: highway and piggyback trailers, van containers.

Loading: hand-loaded or palletized with filament tape.

Corn, Sweet (*Zea mays*)

Availability: year-round, Florida, New York, California, New Jersey, and many other States; Mexico.

Grade: U.S. Fancy, No. 1, and No. 2.

Precooling: hydrocool, hydrovacuum cool, package-ice.

Temperature & Relative Humidity: 0°C (32°F), 95-98%.

Sensitivity: very high respiration rate and moisture loss; freezing at -0.5 °C (31°F).

Transit & Storage Life: 5-8 days.

Packaging: wirebound wood crates, 4-1/2 to 5 dozen, 19 kg (42 lb), also waxed fiberboard box, 5 dozen, 23 kg (50 lb).

Transportation: highway and piggyback trailers, van containers.

Loading: hand-loaded, top-iced.

Cucumbers (*Cucumis sativas*)

Availability: year-round, Michigan, North Carolina, California, Ohio, South Carolina, Texas, Oregon, Florida and many other States; Mexico, Bahamas, Jamaica, Honduras, Canada, Dominican Republic.

Grade: U.S. Fancy, Extra No. 1, No. 1, No. 1 Small, No. 1 Large, and No. 2.

Treatments: waxing, fungicides.

Precooling: forced-air, hydrocool.

Temperature & Relative Humidity: 10-13°C (50-55°F), 95%.

Sensitivity: chilling injury below 10°C (50°F); moisture loss; ethylene sensitive.

Transit & Storage Life: 10-14 days.

Packaging: one-piece waxed fiberboard box or wirebound wood crate, 0.039 cu m (1-1/9 bu), 25 kg (55 lb); 0.035 cu m (1 bu), 21 kg (47 lb); place pack 13.6 kg (30 lb).

Transportation: highway and piggyback trailers, van containers.

Loading: palletized or hand-loaded.

Custard Apple (*Annona reticulata*)

Availability: November-April, California, Florida, Chile.

Grade: spherical yellowish-green fruit with scales, 70-120 mm (3.5-5.5 in).

Precooling: forced air, room cool.

Temperature & Relative Humidity: 5° to 7°C (41-45°F), 85-90%.

Sensitivity: chilling injury; bruising.

Transit & Storage Life: 4-6 weeks.

Packaging: single layer pack in fiberboard box with paper or foam wrapping or excelsior to reduce bruising. 5 kg (12 lb).

Transportation: highway and piggyback trailers, van containers.

Daikon (Black radish, *Raphanus sativus*, var. *niger*)

Availability: year-round, Florida, California, Dominican Republic,
Grade: long white root up to 300 mm (12 in) long, usually topped.
Precooling: hydrocool.

Temperature & Relative Humidity: 0° to 1°C (32-34°F), 95-100%.

Sensitivity: moisture loss.

Transit & Storage Life: 4 months, topped; 2 weeks bunched.

Packaging: full telescoping fiberboard box, wirebound wood crates, 0.039 cu m (1-1/9 bu), 23 kg (50 lb); boxes, crates, lugs, 11 kg (25 lb).

Transportation: highway and piggyback trailers, van containers.

Durian (*Durio zibethinus*)

Availability: April-July, Bahamas, Dominican Republic, Haiti, Jamaica, Central America, South America.

Grade: olive green thorned skin, 150-350 mm (6-14 in) long, 150-250 mm (6-10 in) diameter, weighing up to 18 kg (40 lb); harvest unripe to minimize odor.

Precooling: forced air, room.

Temperature & Relative Humidity: 4° to 6°C (39-43°F) 85-90%.

Sensitivity: gives off a very offensive odor when ripening, keep separate from other products.

Transit & Storage Life: 6-8 weeks.

Packaging: single layer pack in fiberboard box with film liner, individually wrap each piece.

Transportation: highway and piggyback trailers, van containers.

Loading: do not ship in mixed loads.

Eggplant (*Solanum melongena*)

Availability: year-round, Florida, New Jersey, Mexico, Dominican Republic, Jamaica.

Grade: U.S. Fancy, No. 1, and No. 2.

Precooling: forced-air, hydrocool.

Temperature & Relative Humidity: 12°C (54°F), 90-95%.

Sensitivity: chilling injury at 10°C (50°F); ethylene sensitive; bruising.

Transit & Storage Life: 1 week.

Packaging: individually paper wrapped, piece-packed in one-piece waxed fiberboard boxes or wirebound crates, 0.039 cu m (1-1/9 bu), 15 kg (33 lb).

Transportation: highway and piggyback trailers, van containers.

Loading: palletized or hand-loaded.

Feijoa (Pineapple guava, *Feijoa sellowiana*)

Availability: year-round, September-January, California, March-June, New Zealand; Florida.

Grade: green skin fruit, 30-100 mm (1.2-4 in) long, 25-50 mm (1-2 in) diameter.

Precooling: forced air.

Temperature & Relative Humidity: 5° to 10°C (41-50°F), 90%.

Sensitivity: chilling injury below 5°C (41°F).

Transit & Storage Life: 2-3 weeks.

Packaging: cell packed fiberboard or wood flats, 25-49 count, 4.5 kg (10 lb).

Transportation: highway and piggyback trailers, van containers.

Figs—Mission, Calimyrna varieties (*Ficus carica*)

Availability: April-September, California.

Grade: yellow or purple skin, depending on variety, pear shape, 80 mm (3.5 in) long.

Precooling: forced air.

Temperature & Relative Humidity: -0.5° to 0°C (31-32°C), 85-90%.

Sensitivity: freezing at -2°C (28°F); ethylene producer; bruising.

Transit & Storage Life: 7-10 days.

Packaging: cell packed, fiberboard tray, 1 layer 2-4 kg (5-8 lb); 2 layer, 5-7 kg (10-15 lb).

Transportation: highway and piggyback trailers, van containers, air cargo containers.

Granadilla (Yellow Passionfruit, *Passiflora edulis* var. *flavicarpa*)

Availability: year-round, California, New Zealand, Australia, South Africa.

Grade: yellow or orange fruit, 50-80 mm (2-3 in) diameter.

Precooling: forced air.

Temperature & Relative Humidity: 10°C (50°F), 85-90%.

Sensitivity: chilling injury.

Transit & Storage Life: 3-4 weeks.

Packaging: cell packed fiberboard or wood flats, 25-49 count, 4.5 kg (10 lb).

Transportation: highway and piggyback trailers, van containers, air cargo containers.

Ginger Root (*Zingiber officinale*)

Availability: year-round, Hawaii, Central America, South America, West Indies.

Grade: Hawaiian No. 1, tight light brown skin.

Precooling: forced air, room cool.

Temperature & Relative Humidity: 13°C (55°F) 65%.

Sensitivity: chilling injury, mold growth and sprouting at higher humidities.

Transit & Storage Life: 6 months.

Packaging: loose pack, full telescoping fiberboard carton, 13.6 kg (30 lb).

Transportation: highway and piggyback trailers, van containers.

Grapefruit (*Citrus paradisi*)

Availability: year-round, Florida, Texas, Arizona, California; Bahamas, Israel, Mexico, Dominican Republic.

Grade: U.S. Fancy, No. 1, No. 1 Bright, No. 1 Golden, No. 1 Bronze, No. 1 Russet, No. 2, No. 2 Bright, No. 2 Russet, Combination, No. 3; Florida Special.

Treatments: waxing, fungicide; degreening with ethylene; curing for cold temperature storage or cold treatment at 16°C (61°F) or 21°C (70°F) for 7 days; cold treatment for fruit fly disinfestation under APHIS supervision.

Precooling: room cool.

Temperature & Relative Humidity: 10° to 15°C (50-60°F), 85-90% for Florida and Texas grown fruit (Duncan, Pink Seedless, Marsh Seedless, and Ruby Red Seedless varieties) depending on time of season; 14° to 15°C (58-60°F), 85-90% for California and Arizona grown fruit.

Sensitivity: chilling injury at 7°C (45°F), early season Florida and Texas fruit may suffer chilling injury below 15°C (60°F).

Transit & Storage Life: 6-8 weeks.

Packaging: full telescoping fiberboard boxes, 0.028 cu m (4/5 bu), 0.024 cu m (7/10 bu), 18 kg (40 lb). Consumer packs in 4 kg (9 lb) film bags, 6 count; 2 kg (5 lb) film bags, 10 count.

Transportation: highway and piggyback trailers, van containers.

Loading: unitized on slipsheets; hand-loaded.

Grapes, Table (*Vitus vinefera*)

Availability: year round, California, Arizona, New York, Michigan, Georgia, Pennsylvania; Chile, Canada, Mexico

Grade: European or Vinefera—U.S. Extra Fancy Table, Extra Fancy Export, Fancy Table, Fancy Export, No. 1 Table; American—U.S. Fancy Table Grapes, No. 1 Table Grapes, No. 1 Juice Grapes. Grapes will not ripen after harvest.

Treatments: sulfur dioxide fumigant for Vinefera grapes only, or sulfur dioxide impregnated pads to limit decay; 10 ppm maximum residue.

Precooling: forced-air cool.

Temperature & Relative Humidity: -1 to -0.5°C (30-31°F) 90-95% for Vinefera grapes; -0.5 to 0°C (31-32°F) 85% for American grapes.

Sensitivity: freezing injury, -2°C (28°F) for Vinefera, -1°C (30°F) for American.

Transit & Storage Life: 1-6 months for Vinefera varieties, 2-8 weeks for American varieties.

Packaging: fiberboard, polystyrene foam, or wood lugs, perforated film liners, 10-11 kg (22-24 lb); some with sulfur dioxide pads.

Transportation: highway and piggyback trailers, van containers, break-bulk vessels.

Loading: unitized on pallets with cornerboards and strapping.

Guava (*Psidium guajava*)

Availability: September-January, California, January-March and June-October, Florida.

Grade: harvest at mature green stage, 90-120 mm (3.5-4.7 in) diameter.

Precooling: forced air.

Temperature & Relative Humidity: 5° to 10°C (41-50°F) 85-90%.

Sensitivity: chilling injury at 2°C (36°F), ethylene producer.

Transit & Storage Life: 2-3 weeks.

Packaging: cell packed fiberboard or wood flat lined with film, 4.5 kg (10 lb)

Transportation: highway and piggyback trailers, van containers.

Haricot Vert (*Phaseolus vulgaris*)

Availability: year-round France, Belgium, The Netherlands, Senegal.

Grade: this pole bean has long, straight, thin flat pods which are harvested before maturity for tenderness.

Precooling: hydrocool.

Temperature & Relative Humidity: 4° to 7°C (39-45°F), 95%.

Sensitivity: chilling injury below 3°C (38°F); ethylene sensitive.

Transit & Storage Life: 7-10 days.

Packaging: fiberboard tray with plastic netting, 5 kg (11 lb).

Transportation: air cargo containers, highway trailers.

Horseradish (*Armoracia rusticana*)

Availability: year-round, Missouri, Oregon.

Grade: U.S. Fancy, No. 1 and No. 2.

Treatments: protect from light, otherwise roots will turn green.

Precooling: hydrocool, room cool.

Temperature & Relative Humidity: -1°C to 0°C (30-32°F), 98-100%.

Sensitivity: freezing injury at -2°C (28°F), high moisture loss rate.

Transit & Storage Life: 10-12 months.

Packaging: film bags, 23 kg (50 lb), 27 kg (60 lb), 2 kg (5 lb).

Transportation: highway and piggyback trailers, van containers.

Jaboticaba (Jabotica, *Myciaria cauliflora*)

Availability: March-June, Florida.

Grade: dark maroon fruit, 25 mm (1 in) diameter.

Precooling: room cool.

Temperature & Relative Humidity: 13° to 15°C (55-60°F), 90-95%.

Sensitivity: chilling injury, moisture loss, absorbs odors.

Transit & Storage Life: 2-3 days

Packaging: fiberboard flats, 4.5 kg (10 lb).

Transportation: air cargo containers.

Jackfruit (Jak Fruit, Jaca, *Artocarpus heterophyllus*)

Availability: year-round, Florida, Puerto Rico.

Grade: large knobby yellow-green fruit, 200-500 mm (8-20 in) long.

Precooling: forced air, room cool.

Temperature & Relative Humidity: 13°C (55°F), 85-90%

Sensitivity: chilling injury, bruising.

Transit & Storage Life: 2-6 weeks.

Packaging: wrap, pad or pack with excelsior in full telescoping fiberboard box, 2-3 count.

Transportation: highway and piggyback trailers, van containers, air cargo containers.

Jaffa Orange (*Citrus sinensis*)

Availability: year-round, Israel, California.

Treatments: ethylene used for degreening.

Precooling: forced air.

Temperature & Relative Humidity: 8° to 10°C (46-50°F), 85-90%.

Sensitivity: chilling injury.

Transit & Storage Life: 8-12 weeks.

Packaging: full telescoping fiberboard box or nailed wood crate, 4.5 kg (10 lb), 9 kg (20 lb).

Transportation: highway and piggyback trailers, van containers.

Japanese Eggplant (*Solanum melongena*)

Availability: February-April, California, Mexico

Grade: white and black varieties, narrow and elongated.

Precooling: forced air.

Temperature & Relative Humidity: 12°C (54°F), 90-95%.

Sensitivity: chilling injury at 10°C (50°F).

Transit & Storage Life: 1 week.

Packaging: full telescoping fiberboard boxes, 0.039 cu m (1-1/9 bu), 15 kg (33 lb), solid fiberboard boxes, 5 kg (11 lb).

Transportation: highway and piggyback trailers, van containers.

Jerusalem Artichoke (Sunchoke, *Helianthus tuberosus*)

Availability: October-April, California, Maine.

Grade: firm, hard, light brown roots.

Precooling: hydrocool.

Temperature & Relative Humidity: 0°C (32°F), 90-95%.

Sensitivity: freezing at -2.5°C (27.5°F), high moisture loss rate.

Transit & Storage Life: 4-5 months

Packaging: one-piece fiberboard boxes with 12 consumer packed 340 g (12 oz) or 0.5 kg (1 lb) film bags.

Transportation: highway and piggyback trailers, van containers.

Jicama (*Pachyrhizus tuberosum*)

Availability: September-June, Florida, Mexico.

Grade: bulbous light brown root, up to 200 mm (8 in) across.

Treatments: hypochlorite dip to reduce decay.

Precooling: room cooling.

Temperature & Relative Humidity: 13° to 18°C (55-65°F) 65-70%.

Sensitivity: chilling injury at lower temperatures; sprouting at higher temperatures; decay at higher humidities.

Transit & Storage Life: 1-2 months.

Packaging: full telescoping fiberboard cartons, 9 kg (20 lb).

Transportation: highway and piggyback trailers, van containers.

Kiwanos (Horned Melon, African Horned Cucumber, *Cucumis metuliferous*)

Availability: August-October, California; February-June, New Zealand.

Grade: spiked fruit, 100-150 mm (4-6 in) long, yellow-orange when ripe.

Precooling: room cool.

Temperature & Relative Humidity: 10° to 15°C (50-60°F), 90%.

Sensitivity: chilling injury, bruising.

Transit & Storage Life: 6 months.

Packaging: full telescoping fiberboard box, tray pack with dividers, paper excelsior, 9 count.

Transportation: highway and piggyback trailers, van containers.

Kiwifruit (Chinese gooseberry, *Actinidia chinensis*)

Availability: November-April, California; May-October, New Zealand; also Chile, France, Australia.

Grade: U.S. Fancy, U.S. No. 1, U.S. No. 2. Size 49 minimum. Mandatory inspection in California.

Treatments: green fruit can be ripened with ethylene.

Precooling: hydrocool, forced air.

Temperature & Relative Humidity: 0°C (32°F), 90-95%.

Sensitivity: freezing injury at -2°C (28°F); ethylene producer/ethylene sensitive.

Transit & Storage Life: 3-5 months.

Packaging: film lined, cell packed fiberboard or wood flats, 33, 36, 39 counts the most popular in the range of 25-49 count, 2.5-4 kg (5.5-8.5 lb); film bags, 0.5 kg (1 lb); one-piece fiberboard boxes, film lined, with interlocking plastic end tabs, 7 kg (16 lb).

Transportation: highway and piggyback trailers, van containers.

Loading: palletized unit loads.

Kohlrabi (*Brassica oleracea*, convar. *acephala*, var. *gongulodes*)

Availability: year-round, California.

Grade: pale green root with leaves attached, 60-76 mm (2.5-3 in) diameter.

Precooling: hydrocool, package-ice.

Temperature & Relative Humidity: 0°C (32°F), 98-100%.

Sensitivity: freezing injury at -1°C (30°F); high moisture loss rate.

Transit & Storage Life: 2-3 months.

Packaging: film lined fiberboard boxes, 12, 18, 24 bunches, 3-5 pieces per bunch; package-ice.

Transportation: highway and piggyback trailers, van containers.

Loading: top-ice.

Kumquat (*Citrus fortunella*)

Availability: November-July, Florida, California, Chile.

Grade: small orange citrus, 25-64 mm (1-2.5 in) long.

Precooling: forced air, room cool.

Temperature & Relative Humidity: 4°C (39°F), 90-95%.

Sensitivity: freezing injury.

Transit & Storage Life: 2-4 weeks.

Packaging: one-piece fiberboard box, 4.5 kg (10 lb); fiberboard box with 16 film bags, 20 count, 227 g (8 oz).

Transportation: highway and piggyback trailers, van containers, air cargo containers.

Leeks (*Allium ampeloprasum*)

Availability: year-round, California, New Jersey, Michigan, Virginia.

Grade: green leaves on necks blanched 50-76 mm (2-3 in) from root.

Precooling: hydrocool, package-ice, vacuum cooling.

Temperature & Relative Humidity: 0°C (32°F), 95-100%.

Sensitivity: freezing injury at -0.5°C (31°F), moisture loss.

Transit & Storage Life: 2-3 months.

Packaging: bunched with rubber band, 1-2 dozen per bunch, in film lined wire-bound or nailed wood crates, or waxed fiberboard boxes, with layers of ice, 1-2 dozen bunches. Sizes include 4/5 bushel, 9 kg (20 lb); 1/2 crate, 14 kg (30 lb).

Also packed in 0.5 kg (1 lb) film bags, 10 count.

Transportation: highway and piggyback trailers, van containers.

Loading: hand-loaded or palletized.

Lemons (*Citrus limon*)

Availability: year-round, Arizona, California, Florida; Spain.

Grade: U.S. No. 1, Export No. 1, Combination, No. 2.; dark green for long term storage.

Treatments: waxing, fungicides, curing in storage prior to shipment at at 14.5 to 15.5°C (58-60°F) for 1 to 4 months.

Precooling: room cool.

Temperature & Relative Humidity: 10-13°C (50-55°F), 85-90%, for conditioned fruit.

Sensitivity: chilling injury below 14.5°C (58°F) for unconditioned fruit, below 7°F (45°F) for conditioned fruit.

Transit & Storage Life: 1-6 months.

Packaging: full telescoping fiberboard box, 17 kg (38 lb).

Transportation: highway and piggyback trailers, van containers, break-bulk vessels.

Loading: unitized on pallets or slipsheets, hand-loaded.

Limes—Key, Mexican, Persian varieties, (*Citrus aurantiifolia*; *Citrus latifolia*)

Availability: year-round, Florida; Mexico, Bahamas, Columbia, Dominican Republic, Haiti, Honduras.

Grade: U.S. No. 1, Combination for Persian limes.

Precooling: room cool

Temperature & Relative Humidity: 9° to 10°C (48-50°F), 85-90%.

Sensitivity: chilling injury at 4°C (39°F).

Transit & Storage Life: 6-8 weeks.

Packaging: two-piece box with cover, 4.5 kg (10 lb), full telescoping fiberboard box, 17 kg (38 lb).

Transportation: highway and piggyback trailers, van containers.

Loading: unitized on pallets and slipsheets, hand-loaded.

Lo Bok (Black radish, Chinese radish, *Raphanus sativus*, var. *niger*)

Availability: year-round, California, Dominican Republic.

Precooling: hydrocool.

Temperature & Relative Humidity: 0° to 2°C (32-36°F), 95-100%.

Sensitivity: freezing injury; high moisture loss rate.

Transit & Storage Life: 2-4 months.

Packaging: full telescoping waxed fiberboard box, wirebound wood crate, 18 kg (40 lb); boxes, crates, lugs 11 kg (25 lb).

Transportation: highway and piggyback trailers, van containers.

Longan (Lungan, *Euphoria longana*)

Availability: July-August, Florida; Bahamas, Dominican Republic, Haiti, Jamaica.

Grade: light brown fruit, 25-40 mm (1-1.5 in) diameter.

Precooling: forced air cool.

Temperature & Relative Humidity: 1.5°C (35°F), 90-95%

Sensitivity: freezing injury, high moisture loss rate.

Transit & Storage Life: 3-5 weeks

Packaging: one-piece fiberboard box, 4.5 kg (10 lb).

Transportation: highway and piggyback trailers, van containers.

Loquat (Japanese plum, *Eriobotrya japonica*)

Availability: year-round; April-May, California; Chile.

Grade: pear-shaped, yellow-orange fruit, 30-90 mm (1-3.5 in) long.

Precooling: forced air cool.

Temperature & Relative Humidity: 0°C (32°F), 90%.

Sensitivity: freezing injury.

Transit & Storage Life: 3 weeks.

Packaging: cell packed fiberboard or wood flats, 25-49 count, 4.5 kg (10 lb).

Transportation: highway and piggyback trailers, van containers, air cargo containers.

Lychee (Litchi, *Litchi chinensis*)

Availability: June-July, Florida, Mexico; September-October, California; Bahamas, Dominican Republic, Haiti, Jamaica.

Grade: rough orange-red fruit, 25-50 mm (.5 in) diameter.

Precooling: forced air.

Temperature & Relative Humidity: 1.5°C (35°F), 90-95%.

Sensitivity: freezing injury, high moisture loss rate.

Transit & Storage Life: 3-5 weeks

Packaging: one-piece fiberboard box, 4.5 kg (10 lb).

Transportation: highway and piggyback trailers, van containers, air cargo containers.

Malanga (Cocoyam, *Yautia*, *Xanthosoma* spp.)

Availability: year-round, Florida, Puerto Rico, Dominican Republic.

Grade: brown hairy corms, 100-250 mm (4-10 in) long.

Precooling: forced air, room cool.

Temperature & Relative Humidity: 7°C (45°F), 70-80%, good ventilation.

Sensitivity: chilling injury; decay at higher humidities and temperatures.

Transit & Storage Life: 3 months.

Packaging: full telescoping ventilated fiberboard boxes, wirebound wood crates, excelsior to reduce bruising, 11 kg (25 lb), 23 kg (50 lb); burlap or woven plastic sacks, 23 kg (50 lb).

Transportation: highway and piggyback trailers, van containers.

Mamey (Mamey sapote, *Calocarpum sapota*)

Availability: July-October, Florida.

Grade: oval, 150-230 mm (6-9 in) long, brown skin, pink flesh, slightly soft when ripe.

Treatments: research needed for acceptable quarantine treatments for entry to the U.S.

Precooling: room cool.

Temperature & Relative Humidity: 13° to 18°C (55-65°F), 85-90%.

Sensitivity: chilling injury; bruising; moisture loss; ethylene producer.

Transit & Storage Life: 2-6 weeks.

Packaging: fiberboard flat, wrapped, foam sleeves, or excelsior, 3 kg (7 lb).

Transportation: highway and piggyback trailers, van containers, air cargo containers.

Mango—Haden, Irwin, Keitt, Kent, Oro, Tommy Atkins varieties. (*Mangifera indica*)

Availability: June-September, Florida; February-September, Puerto Rico, Mexico, West Indies, Central America, Chile.

Grade: green-yellow to red blush depending on variety, ship only fruit that has begun to change from green color. Keitt and Kent are larger varieties, weighing up to 1 kg (36 oz) compared to 0.5 kg (18 oz) for other varieties.

Treatments: hot water dip mature-green fruit to retard decay. Use ethylene or room temperature to ripen. EDB fumigation is being replaced with a hot water double-dip treatment for fruit fly eradication.

Precooling: forced air.

Temperature & Relative Humidity: 13°C (55°F), 85-90%.

Sensitivity: chilling injury at 10°C (50°F), especially Haden and Keitt varieties; ethylene producer.

Transit & Storage Life: 2-3 weeks.

Packaging: one layer, two-piece fiberboard box with cover, 9-16 count, 4.5-6 kg (10-13 lb).

Transportation: highway and piggyback trailers, van containers.

Loading: unitized on pallets.

Mangosteen (*Garcinia mangostana*)

Availability: year-round, Puerto Rico, Mexico, Belize, West Indies, Trinidad and Tobago.

Grade: purple fruit, 40-80 mm (1.5-3 in) diameter, must be picked ripe.

Precooling: forced air.

Temperature & Relative Humidity: 13°C (55°F), 85-90%.

Sensitivity: chilling injury; ethylene producer.

Transit & Storage Life: 2-4 weeks.

Packaging: cell packed fiberboard or wood flats, 25-49 count, 4.5 kg (10 lb).

Transportation: highway and piggyback trailers, van containers.

Melons—Casaba, Crenshaw, Honeydew, and Persian varieties (*Cucumis melo*)

Availability: year-round, California, Texas, Arizona, Mexico, Guatemala, Costa Rica, El Salvador, Honduras, Jamaica, Panama.

Grade: U.S. No. 1, Commercial, No. 2. for honeydew melons.

Treatments: ethylene treatment for 18-24 hours for uniform ripening of honeydew melons at 20°C (68°F).

Precooling: forced air cool.

Temperature & Relative Humidity: 7° to 10°C (45-50°F), 90%. Casaba melons should be held at 10°C.

Sensitivity: chilling injury below 7°C (45°F); Honeydew is an ethylene producer.

Transit & Storage Life: 3 weeks, Casaba, Honeydew; 2 weeks, Crenshaw, Persian.

Packaging: 2/3 size box, Bliss style fiberboard box, 184 mm (7.25 in) deep, 4, 5, 6, 8 count, 11-14.5 kg (25-32 lb), also packed in nailed wood crates with excelsior padding.

Transportation: highway and piggyback trailers, van containers.

Loading: unitized on pallets or hand-loaded.

Okra (*Abelmoschus esculentus*)

Availability: year-round, California, Florida, Texas, Mexico, Dominican Republic.

Grade: U.S. No. 1.

Precooling: forced air.

Temperature & Relative Humidity: 7° to 10°C (45-50°F), 90-95%.

Sensitivity: chilling injury below 7°C (45°F); moisture loss, however, do not top-ice or sprinkle with water; bruising; ethylene sensitive.

Transit & Storage Life: 7-10 days.

Packaging: 0.035 cu m (1 bu) crates, 14 kg (30 lb); 0.020 cu m (5/9 bu) crates, one-piece fiberboard boxes, 11 liter (12 qt) baskets, 8 kg (18 lb).

Transportation: highway and piggyback trailers, van containers. air cargo containers.

Oranges—Navel, Valencia, Temple, Parson Brown, Pineapple, and Hamlin varieties (*Citrus sinensis*).

Availability: year-round, California, Florida, Arizona, Texas; Dominican Republic, Jamaica.

Grade: U.S. Fancy, No. 1 Bright, No. 1, Combination, No. 1 Golden, No. 1 Bronze, No. 1 Russet, No. 2 Bright, No. 2, No. 2 Russet, No. 3.

Treatments: waxing; fungicides or biphenyl-treated pads in packaging to limit decay; ethylene for degreening.

Precooling: room cool, forced-air, hydrocool.

Temperature and Relative Humidity: 3° to 9°C (37-48°F) for California and Arizona grown fruit; 0° to 1°C (32-34°F) for Florida and Texas grown fruit.

Sensitivity: chilling injury below 3°C (38°F) on California and Arizona grown fruit; freezing injury at -0.7°C (31°F).

Transit & Storage Life: 3-8 weeks, California and Arizona grown fruit, 8-12 weeks, Florida and Texas grown fruit.

Packaging: full telescoping fiberboard box, place-packed, 18 kg (40 lb); 0.028 cu m (4/5 bu), 20 kg (45 lb); 0.024 cu m (7/10 bu) 20 kg (45 lb); 0.049 cu m (1-2/5 bu), 39 kg (86 lb).

Transportation: highway and piggyback trailers, van containers.

Loading: unitized on slipsheets, pallets, or hand-loaded.

Papaya—Pawpaw, Solo varieties, (*Carica papaya*)

Availability: year-round, Florida, Hawaii, Puerto Rico, Mexico, West Indies, Belize, Chile, Phillipines.

Grade: Hawaiian No. 1, harvested mature green, marketed one quarter to three quarter ripe, green to yellow-orange.

Treatments: hot water double-dip for fruit fly eradication and control of decay, at quarter ripe stage. Ripen at 21° to 27°C (70-81°F).

Precooling: forced air.

Temperature & Relative Humidity: 7° to 13°C (45-55°F), 85-90%.

Sensitivity: chilling injury below 7 C (45 F); bruising; ethylene producer.

Transit & Storage Life: 1-3 weeks.

Packaging: foam mesh sleeve on each piece of fruit, foam pad on bottom of box, or paper wrapping. Single layer, one-piece fiberboard box, 6-12 count, 4.5 kg (10 lb).

Transportation: air cargo containers, highway and piggyback trailers, van containers.

Passionfruit (*Passiflora edulis*)

Availability: year-round, April-August, Florida; November-January, California; February-July, New Zealand; Australia.

Grade: 50-80 mm (2-3 in) diameter, ripe fruit has purple wrinkled skin.

Precooling: forced air.

Temperature & Relative Humidity: 7° to 10°C (45-50°F), 95%.

Sensitivity: chilling injury, moisture loss; ethylene producer.

Transit & Storage Life: 3-5 weeks.

Packaging: cell packed fiberboard or wood flat, 25-49 count, 4.5 kg (10 lb).

Transportation: highway and piggyback trailers, van containers, air cargo containers.

Papino (Mellowfruit, Treemelon, *Solanum muricatum*)

Availability: August-December, California; February-June, New Zealand.

Grade: oval shaped, 50-100 mm (2-4 in) long, purple stripes on a greenish-yellow skin. Green color will turn yellow when ripe.

Precooling: forced air, room cool.

Temperature & Relative Humidity: 4°C (39°F), 85-90%.

Sensitivity: chilling injury.

Transit & Storage Life: 1 month.

Packaging: fiberboard tray pack, 4.5 kg (10 lb).

Transportation: highway and piggyback trailers, van containers.

Peppers (*Capsicum spp.*)

Availability: year-round, Florida, Texas, California, Mexico, Dominican Republic;

gourmet bell peppers, March-November, Florida, Jamaica, The Netherlands

Grade: U.S. Fancy, No. 1, and No. 2. Quality including size and appearance of gourmet peppers is very high. Colors include purple, yellow, red, and white.

Treatments: light waxing.

Precooling: forced air.

Temperature & Relative Humidity: 7° to 13°C (45-55°F), 90-95%.

Sensitivity: chilling injury below 7°C (45°F); ethylene sensitive.

Transit & Storage Life: 2-3 weeks.

Packaging: one-piece fiberboard box, 0.039 cu m (1-1/9 bu), 13 kg (28 lb); 0.035 cu m (1 bu), 11 kg (25 lb); gourmet peppers, full telescoping solid fiberboard boxes 5 kg (11 lb).

Transportation: highway and piggyback trailers, van containers, air cargo containers.

Loading: palletized or hand-loaded.

Persimmon (*Diospyros kaki*)

Availability: year-round; October-January, California; Italy, Israel, Spain.

Grade: yellow to orange fruit, 100 mm (4 in) diameter; California State regulations.

Treatments: astringency, which causes puckering of the consumers mouth, is removed with carbon dioxide or ethylene treatments. Ethylene, however, will cause ripening, reducing subsequent shelf life.

Precooling: forced air.

Temperature & Relative Humidity: -1°C (30°F), 90%.

Sensitivity: freezing injury at -2°C (28°F); ethylene producer.

Transit & Storage Life: 3-4 months.

Packaging: film lined, tray packed, fiberboard or wood flats, 4-5 kg (9-11 lb), 2 layer film lined, tray packed, one-piece fiberboard box 10 kg (22 lb).

Transportation: highway and piggyback trailers, van containers.

Pineapple (*Ananas comosus*)

Availability: year-round, Hawaii, Puerto Rico, Mexico, Dominican Republic, Honduras, Costa Rica, Phillipines, Columbia, Ivory Coast.

Grade: U.S. Fancy, No. 1, and No. 2.; Hawaii Fancy, No. 1, and Cocktail. Will not continue to ripen after harvest.

Treatments: fungicide to reduce decay.

Precooling: forced air, room cool.

Temperature & Relative Humidity: 7°to 13°C (45-55°F).

Sensitivity: chilling injury below 7°C (45°F).

Transit & Storage Life: 2-4 weeks.

Packaging: one-piece and full telescoping fiberboard boxes, 9 kg (20 lb), 18 kg (40 lb).

Transportation: air cargo containers, highway and piggyback trailers, van containers.

Loading: hand-loaded and unitized on pallets.

Plantain (*Musa sp.*)

Availability: year-round, Caribbean, Central America, South America.

Grade: shipped green.

Treatments: ethylene absorbent pads can be placed in the boxes.

Precooling: forced air, room cool, cool in transit.

Temperature & Relative Humidity: 13° to 14°C (55-58°F), 90-95%.

Sensitivity: chilling injury at 12°C (54°F); ethylene producer/ethylene sensitive; bruising.

Transit & Storage Life: 1-5 weeks depending on ripeness.

Packaging: film lined full telescoping fiberboard boxes, 23 kg (50 lb).

Transportation: highway and piggyback trailers, van containers.

Loading: hand-loaded or unitized on pallets.

Pomegranate (*Punica granatum*)

Availability: August-December, California; July-March, Israel.

Grade: thick red skinned fruit, 76-100 mm (3-4 in) diameter; California State regulations.

Precooling: hydrocool, forced air.

Temperature & Relative Humidity: 5°C (41°F), 90-95%.

Sensitivity: chilling injury after 2 months at 5°C (41°F), can be held at 0°C (32°F) for 1 month without damage.

Transit & Storage Life: 2-3 months.

Packaging: cell packed or place packed with plastic excelsior, 24-30 count, 2 layers, nailed wood lugs or one-piece fiberboard boxes, 11 kg (25 lb).

Transportation: highway and piggyback trailers, van containers.

Loading: unitized on pallets.

Pummelo (*Citrus grandis*)

Availability: January-February, California; October-February, Florida; December-April, Israel.

Grade: light green to yellow fruit depending on maturity, 200-300 mm (8-12 in) diameter.

Precooling: forced air.

Temperature & Relative Humidity: 7° to 9°C (45-48°F) 85-90%

Sensitivity: chilling injury.

Transit & Storage Life: 12 weeks.

Packaging: two-piece fiberboard boxes, 4.5 kg (10 lb); 0.028 cu m (4/5 bu) full telescoping fiberboard box, 18 kg (40 lb).

Transportation: highway and piggyback trailers, van containers.

Pumpkin (*Cucurbita maxima* and *Cucurbita moschata*)

Availability: year-round, Colorado, California and many other U.S. States in October; Puerto Rico, Costa Rica, Dominican Republic, Jamaica, Venezuela.

Grade: colors, sizes vary, depending on variety.

Precooling: room cool.

Temperature & Relative Humidity: 10° to 13°C (50-55°F), 50-70%

Sensitivity: chilling injury below 10°C (50°F).

Transit & Storage Life: 2-3 months.

Packaging: bulk wood or fiberboard bins, 363-408 kg (800-900 lb); mesh sacks, 23 kg (50 lb); 1/2 wirebound or nailed wood crates, 18 kg (40 lb); 0.039 cu m (1-1/9 bu) crates 19 kg (42 lb).

Transportation: highway and piggyback trailers, van containers.

Quince (*Cydonia oblonga*)

Availability: year-round, August-November, California; July-April, Argentina, Chile.

Grade: round to pear shaped, greenish-yellow fruit, 125 mm (5 in) long.

Treatments: fungicides to prevent decay; ripen at 20°C (68°F) for processing.

Precooling: forced air, room cooling.

Temperature & Relative Humidity: -0.5°C (31°F), 90-95%.

Sensitivity: freezing at -2°C (28°F); ethylene producer.

Transit & Storage Life: 2-3 months.

Packaging: 2 layer tray pack, wood lugs and one-piece fiberboard boxes, 6 kg (13 lb).

Transportation: highway and piggyback trailers, van containers.

Raddichio (Red-leaved chicory, *Cichorium intybus*, var. *foliosum*)

Availability: year-round, Italy, Florida, California.

Grade: compact small purple heads, 100-125 mm (4-5 in) diameter.

Precooling: vacuum cooling.

Temperature & Relative Humidity: 0° to 1°C (32-34°F), 95-100%.

Sensitivity: freezing below 0°C (32°F), high moisture loss rate.

Transit & Storage Life: 2-3 weeks.

Packaging: perforated film covered nailed wood, fiberboard or polystyrene foam trays, 16 count, 3 kg (7 lb); plastic containers with 2 heads each and recipe brochures.

Transportation: highway and piggyback trailers, van containers, air cargo containers.

Rhubarb (*Rheum rhabarbarum*)

Availability: year-round, Washington, Oregon, California.

Grade: U.S. Fancy, No. 1, No. 2; Washington State standards for hothouse or cellar grown, Extra Fancy, Fancy. Trim, leaving 6 mm (1/4 in) leaf top.

Precooling: hydrocool, forced air.

Temperature & Relative Humidity: 0°C (32°F), 95-100%.

Sensitivity: freezing injury at -2°C (28°F); high moisture loss.

Transit & Storage Life: 2-4 weeks.

Packaging: bunched or loose in heavily waxed, perforated film lined, ventilated one-piece fiberboard box, 9 kg (20 lb); 10 perforated film bags of 25 mm (1 in) long pieces or whole stalks, 0.5 kg (1 lb), in fiberboard box, 4.5 kg (10 lb).

Transportation: highway and piggyback trailers, van containers.

Salsify (Oyster plant, *Tragopogon porrifolius*)

Availability: September-June, California; Belgium, The Netherlands, Costa Rica, West Indies, France.

Grade: topped light brown slender roots, 230-300 mm (9-12 in) long.

Precooling: hydrocool.

Temperature & Relative Humidity: 0°C (32°F), 95-98%.

Sensitivity: freezing injury at -1°C (30°F); high moisture loss rate.

Transit & Storage Life: 2-4 months.

Packaging: 5 film bags, 2 kg (4 lb) each, in solid fiberboard cartons, 10 kg (22 lb).

Transportation: highway and piggyback trailers, van containers.

Sapodilla (*Achras sapote*)

Availability: St. Kitts, St. Lucia, St. Vincent.

Grade: oval brown rough surface fruit, 30-80 mm (1-1/4 to 3 in) long.

Precooling: room cool.

Temperature & Relative Humidity: 16° to 20°C (61-68°F), 85-90%.

Sensitivity: chilling injury.

Transit & Storage Life: 2-3 weeks.

Packaging: cell packed fiberboard or wood flats, 25-49 count, 4.5 kg (10 lb).

Transportation: highway and piggyback trailers, van containers, air cargo containers.

Scorzonera (Black Salsify, *Scorzonera hispanica*)

Availability: October-May, Belgium, The Netherlands.

Grade: brown-black skinned root, 200-400 mm (8-16 in) long.

Precooling: hydrocool, room cool.

Temperature & Relative Humidity: 0° to 1°C (32-34°F), 95-98%.

Sensitivity: freezing injury, moisture loss.

Transit & Storage Life: 6 months.

Packaging: film bags, 2 kg (5 lb), full telescoping fiberboard box, 10 kg (22 lb).

Transportation: highway and piggyback trailers, van containers.

Seedless Cucumbers (Greenhouse cucumbers, *Cucumis sativas*)

Availability: year-round, grown hydroponically in greenhouses in many States, The Netherlands, Spain.

Grade: U.S. Fancy, No. 1 and No. 2.

Treatments: waxed and shrink-wrapped to reduce moisture loss.

Precooling: forced air, room cool.

Temperature & Relative Humidity: 10° to 13°C (50-55°F), 85-90%.

Sensitivity: chilling injury below 10°C (50°F); ethylene will turn cucumbers yellow; moisture loss.

Transit & Storage Life: 10-14 days.

Packaging: shrink-wrapped, 2 layers in fiberboard trays, 12-20 count, 7 kg (16 lb).

Transportation: highway and piggyback trailers, van containers, air cargo containers.

Snow Peas (Sugar peas, *Psium sativum*, convar. *axiphium*)

Availability: year-round; May-September, California; Florida, Dominican Republic, Guatemala.

Grade: flat edible pod varieties; use U.S. Fancy and No. 1. as a guide.

Precooling: hydrocool, hydrovacuum cool, forced air, package-ice.

Temperature & Relative Humidity: 0° to 1°C (32-34°F) 90-95%.

Sensitivity: freezing injury at -0.5°C (31°F), moisture loss.

Transit & Storage Life: 1-2 weeks.

Packaging: one-piece waxed ventilated fiberboard boxes or wirebound wood crates, 4.5 kg (10 lb), 9 kg (20 lb).

Transportation: highway and piggyback trailers, van containers.

Loading: unitized on pallets.

Squash, Summer—Soft shell varieties Yellow Straightneck, Yellow Crookneck, White Scallop, Zucchini, Sunburst, Spaghetti, (*Cucurbita pepo*)

Availability: year-round, Florida, California, Texas, and many other States; Mexico, Costa Rica, Dominican Republic, Jamaica.

Grade: U.S. No. 1, No. 2.

Precooling: room cool, forced-air.

Temperature & Relative Humidity: 5° to 10°C (41-50°F), 95%.

Sensitivity: chilling injury below 5°C; bruising; ethylene sensitive.

Transit & Storage Life: 1-2 weeks.

Packaging: fiberboard boxes, wood lugs, 11-13.5 kg (24-30 lb); 3/4 lugs and boxes, 8-10 kg (18-22 lb), 0.017 cu m (1/2 bu) wood crates, fiberboard boxes, 9.5 kg (21 lb).

Transportation: highway and piggyback trailers, van containers.

Squash, Winter—Hard shell varieties, Acorn or Table Queen, Turban, Delicata, Butternut, Sweet Dumpling, Kobocho, Golden Nugget, Buttercup, (*Cucurbita Maxima* and *Cucurbita Moschata*)

Availability: year-round, Florida, California, Texas, and many other States; Mexico, Costa Rica, Dominican Republic, Jamaica.

Grade: U.S. No. 1 and No. 2.

Precooling: room cool, forced-air.

Temperature & Relative Humidity: 10° to 13°C (50-55°F), 50-70%.

Sensitivity: chilling injury below 10° C (50° F); ethylene sensitive.

Transit & Storage Life: 2-3 months.

Packaging: fiberboard boxes, wood crates, 0.020 cu m (5/9 bu), 9 kg (20 lb), 0.039 cu m (1-1/9 bu) crates, 19 kg (42 lb); wirebound wood crates 20-23 kg (45-50 lb), bulk fiberboard or wood bins 363-408 kg (800-900 lb).

Transportation: highway and piggyback trailers, van containers.

Strawberries (*Fragaria spp.*)

Availability: year-round, California, Florida; Canada, Mexico, New Zealand, Ecuador, Costa Rica, Chile.

Grade: U.S. No. 1, Combination, and No. 2. Gourmet packs with long stems also are offered.

Treatments: modified atmosphere packaging to limit decay.

Precooling: forced-air.

Temperature & Relative Humidity: 0°C (32°C), 90-95%.

Sensitivity: freezing at -1°C (30°F).

Transit & Storage Life: 5-7 days.

Packaging: self-locking fiberboard tray, volume fill, place pack or 12 count 0.5 liter (1 pt) baskets or 6 count 1 liter (1 qt) baskets, 4.5-6 kg (10-13 lb). Pallet loads are covered with a plastic bag and a modified atmosphere of elevated carbon dioxide is applied.

Transportation: air cargo containers, highway trailers.

Loading: unitized on pallets in trailers.

Sugar Apple (Sweetsop, *Annona squamosa*)

Availability: June-September, Florida.

Grade: scaly green heart shaped fruit, 100 mm (4 in) long.

Precooling: forced air, room cool.

Temperature & Relative Humidity: 7°C (45°F), 85-90%

Sensitivity: chilling injury; bruising.

Transit & Storage Life: 4 weeks.

Packaging: wrapped, single layer, one-piece fiberboard box, 4.5 kg, (10 lb).

Transportation: highway and piggyback trailers, van containers, air cargo containers.

Tamarillo (Tree tomato, *Cyphomandra betacea*)

Availability: year-round, New Zealand, Haiti.

Grade: oval fruit, orange to red or purple skin depending on ripeness, 40-70 mm (1.5-2.5 in) long.

Precooling: forced air, room cool.

Temperature & Relative Humidity: 3° to 4°C (37-39°F), 85-90%.

Sensitivity: chilling injury.

Transit & Storage Life: 10 weeks.

Packaging: film lined cell packed fiberboard or wood flats, 25-49 count, 4.5 kg (10 lb).

Transportation: highway and piggyback trailers, van containers, air cargo containers.

Tamarind (*Tamarindus indica*)

Availability: year-round; May-July, August-November, Florida; Puerto Rico, Mexico, West Indies, Central America.

Grade: both green immature and brown ripe pods are shipped; 50-200 mm (2-8 in) long.

Precooling: forced air, room cool.

Temperature & Relative Humidity: 7°C (45°F), 90-95%.

Sensitivity: chilling injury.

Transit & Storage Life: 3-4 weeks

Packaging: film lined fiberboard full telescoping boxes, loose pack, 18 kg (40 lb); film bags, 0.5 kg (1 lb), 4.5 kg (10 lb).

Transportation: highway and piggyback trailers, van containers, air cargo containers.

Tangerines (*Citrus reticulata*)

Availability: October-May, California, Florida, Arizona, Mexico, Spain.

Grade: U.S. Fancy, No. 1, No. 1 Bronze, No. 1 Russet, No. 2, No. 2 Russet and No. 3.

Treatments: waxing; fungicides; ethylene for ripening.

Precooling: room cool, forced-air.

Temperature & Relative Humidity: 4°C (39°F), 90-95%.

Sensitivity: chilling injury at 1°C (33°F).

Transit & Storage Life: 2-4 weeks.

Packaging: full telescoping fiberboard box or wirebound wood crate, 0.028 cu m (4/5 bu), 22 kg (48 lb); 0.017 cu m (1/2 bu), 11 kg (25 lb); 1.4 kg (3 lb) film bags, 16 count.

Transportation: highway and piggyback trailers, van containers.

Taro Root (Dasheen, Eddo, *Colocasia esculenta*)

Availability: year-round, Florida, Hawaii, American Samoa, Central & South America, West Indies.

Grade: brown segmented roots, up to 140 mm (5.5 in) long; should be free of cuts to limit decay.

Precooling: room cool.

Temperature & Relative Humidity: 7° to 10°C (45-50°F) 85-90%.

Sensitivity: chilling injury.

Transit & Storage Life: 4-5 months.

Packaging: burlap sacks, full telescoping fiberboard boxes, 23 kg (50 lb).

Transportation: highway and piggyback trailers, van containers.

Tomatillos (Husk tomatoes, *Physalis peruviana*)

Availability: year-round, California, Mexico, Central America.

Grade: green fruit with grayish-brown husks, 40 mm (1.5 in).

Precooling: room cool, forced air.

Temperature & Relative Humidity: 13° to 15°C (55-60°F), 85-90%.

Sensitivity: chilling injury.

Transit & Storage Life: 3 weeks.

Packaging: one-piece fiberboard box, 4.5 kg (10 lb).

Transportation: highway and piggyback trailers, van containers.

Tomatoes (*Lycopersicon esculentum*)

Availability: year-round, Florida, California, many other States: Canada, Mexico, Dominican Republic, Jamaica, The Netherlands.

Grade: U.S. No. 1, Combination, No. 2, and No. 3.

Treatments: ethylene for rapid and uniform ripening.

Precooling: room cool, forced-air.

Temperature & Relative Humidity: 18° to 22°C (65-72°F), 90-95% for mature green tomatoes; 13° to 15°C (55-60°F) for firm ripe tomatoes.

Sensitivity: chilling injury of mature green tomatoes at 13°C (55°F), ripe tomatoes injured below 7°C (45°F); ethylene producer.

Transit & Storage Life: 1-3 weeks, mature green; 4-7 days firm-ripe.

Packaging: fiberboard box with cover, loose pack, 11 kg (25 lb); fiberboard flat tray, 2-layer place pack, 8-11 kg (18-25 lb); fiberboard lug with cover, 3-layer place pack, 11-15 kg (25-33 lb).

Transportation: air cargo containers, highway and piggyback trailers, van containers.

Loading: boxes and lugs are hand-loaded, flats are palletized.

Ugli Fruit (*Citrus hybrid*)

Availability: February-June, Florida, Jamaica.

Grade: yellowish-green citrus fruit, 160 mm (6.25 in) diameter.

Treatments: degreen with ethylene.

Precooling: forced air, room cool.

Temperature & Relative Humidity: 4°C (39°F), 90-95%.

Sensitivity: chilling injury.

Transit & Storage Life: 2-3 weeks.

Packaging: full telescoping fiberboard box, 0.028 cu m (4/5 bu), 18 kg (40 lb); 2 kg (4 lb) or 4 kg (9 lb) film bags in fiberboard boxes.

Transportation: highway and piggyback trailers, van containers.

Waterchestnut (*Trapa natans, Eleocharis dulcis*)

Availability: year-round, Georgia.

Grade: brown-skinned, bulb-shaped root, 40 mm (1.5 in) diameter.

Treatments: sodium hypochlorite dip to reduce decay.

Precooling: forced air.

Temperature & Relative Humidity: 0° to 2°C (32-36°F), 98-100%.

Sensitivity: high moisture loss rate.

Transit & Storage Life: 1-2 months.

Packaging: packed in film bags with moist sphagnum moss,

Transportation: highway and piggyback trailers, van containers.

Watercress (*Nasturtium officinale*)

Availability: year-round, Florida, California, West Indies.

Grade: long thin stalks with heart shaped dark green leaves.

Precooling: hydrocool, vacuum cool, package-ice and top-ice in storage

Temperature & Relative Humidity: 0°C (32°F), 95-100%

Sensitivity: high moisture loss rate; ethylene sensitive.

Transit & Storage Life: 2-3 weeks

Packaging: bunched, package-iced in heavily waxed one-piece fiberboard boxes or wirebound wood crates with film liners, 12 bunches, 3 kg (7 lb), 24 bunches, 6 kg (13 lb). Bunches also are placed in film bags in boxes.

Transportation: highway and piggyback trailers, van containers.

Loading: palletized loads with top-ice.

Watermelon (*Citrullus lanatus*, *cucurbit*)

Availability: year-round, March-October, Florida, Texas, California, many other States; November-June, Mexico, Panama, Guatemala, El Salvador, Dominican Republic, Venezuela, Honduras, Costa Rica.

Grade: U.S. Fancy, No. 1, and No. 2.

Precooling: room cool.

Temperature & Relative Humidity: 10° to 15°C (50-60°F), 90%.

Sensitivity: chilling injury below 10°C; ethylene sensitive.

Transit & Storage Life: 2-3 weeks.

Packaging: fiberboard flat trays with dividers, 2 or 3 count, 27-34 kg (60-76 lb); bulk fiberboard or wood bins, 454-544 kg (1000-1200 lb).

Transportation: highway and piggyback trailers, van containers.

Loading: some melons are bulk loaded on straw.

White Asparagus (*Asparagus officinalis*, var. *atilis*)

Availability: February-April, California; Belgium, The Netherlands.

Grade: U.S. No. 1 and No. 2 as a guide.

Precooling: hydrocool.

Temperature & Relative Humidity: 0° to 2°C (32-36°F), 95-100%.

Sensitivity: freezing injury at -1°C (31°F); high moisture loss rate.

Transit & Storage Life: 2-3 weeks.

Packaging: wood pyramid crate or fiberboard tray with film sleeved bunches, 4 kg (9 lb), 7 kg (15 lb); moisture pad in crate.

Transportation: highway and piggyback trailers, van containers.

White Sapote (*Casimiroa edulis*)

Availability: May-August, Florida; August-November, California.

Grade: yellow to yellowish green fruit, 60-120 mm (2.5 to 4.5 inch) diameter

Precooling: room cool.

Temperature & Relative Humidity: 19° to 21°C (67-70°F), 85-90%

Sensitivity: chilling injury.

Transit & Storage Life: 2-3 weeks.

Packaging: wrapped single layer one-piece fiberboard box, 4.5 kg (10 lb).

Transportation: highway and piggyback trailers, van containers, air cargo containers.

Winged Bean (*Asparagus pea*, *Psophocarpus tetragonolobus*)

Availability: Florida.

Grade: harvest edible pods at one-half to three-fourths maturity for tenderness.

Precooling: hydrocool, forced air.

Temperature & Relative Humidity: 10°C (50°F) 90%.

Sensitivity: chilling injury.

Transit & Storage Life: 4 weeks.

Packaging: 0.017 cu m (1/2 bu) wirebound crates or fiberboard boxes.

Transportation: highway and piggyback trailers, van containers

Yam (Name, *Dioscorea* spp., including *rotundata* (white yam), *alata* (water yam), *cayenensis* (yellow guinea yam), *esculenta* (potato yam), *bulbifera* (aerial yam), *trifida* (cush-cush yam).

Availability: year-round, Caribbean, Central America.

Treatments: fumigation with methyl bromide; curing at 29° to 32°C (84-90°F) at 90-95% relative humidity for, 4-8 days.

Precooling: room cool.

Temperature & Relative Humidity: 16°C (61°F), 70-80%.

Sensitivity: chilling injury below 13°C (55°F), decay at higher humidities; ethylene sensitive.

Transit & Storage Life: 6-7 months.

Packaging: full telescoping fiberboard cartons with paper wrapping or excelsior to reduce bruising, loose pack, 11 kg (25 lb), 23 kg (50 lb).

Transportation: highway and piggyback trailers, van containers.

Loading: hand-loaded or unitized on pallets.

Yucca Root (Cassava, *Manihot esculenta*)

Availability: year-round, Florida, Mexico, Central America, South America, West Indies.

Grade: thick root, brown skin, white flesh, 150-250 mm (6-10 in) long.

Treatments: sodium hypochlorite to reduce decay.

Precooling: hydrocool, forced air.

Temperature & Relative Humidity: 0° to 5°C (32-41°F) 85-90%.

Sensitivity: bruising.

Transit & Storage Life: 1-2 months.

Packaging: full telescoping fiberboard boxes, 23 kg (50 lb) with excelsior or paper wrapping and padding.

Transportation: highway and piggyback trailers, van containers.

Table 10: Recommended temperature and relative humidity, and approximate transit and storage life for fruits and vegetables.

Product	Temperature		Relative Humidity (percent)	Approximate storage life
	°C	°F		
Amaranth	0-2	32-36	95-100	10-14 days
Anise	0-2	32-36	90-95	2-3 weeks
Apples	-1-4	30-40	90-95	1-12 months
Apricots	-0.5-0	31-32	90-95	1-3 weeks
Artichokes, globe	0	32	95-100	2-3 weeks
Asian pear	1	34	90-95	5-6 months
Asparagus	0-2	32-35	95-100	2-3 weeks
Atemoya	13	55	85-90	4-6 weeks
Avocados, Fuerte, Hass	7	45	85-90	2 weeks
Avocados, Lula, Booth-1	4	40	90-95	4-8 weeks
Avocados, Fuchs, Pollock	13	55	85-90	2 weeks
Babaco	7	45	85-90	1-3 weeks
Bananas, green	13-14	56-58	90-95	1-4 weeks
Barbados cherry	0	32	85-90	7-8 weeks
Bean sprouts	0	32	95-100	7-9 days
Beans, dry	4-10	40-50	40-50	6-10 months
Beans, green or snap	4-7	40-45	95	7-10 days
Beans, lima, in pods	5-6	41-43	95	5 days
Beets, bunched	0	32	98-100	10-14 days
Beets, topped	0	32	98-100	4-6 months
Belgian endive	2-3	36-38	95-98	2-4 weeks
Bitter melon	12-13	53-55	85-90	2-3 weeks
Black sapote	13-15	55-60	85-90	2-3 weeks
Blackberries	-0.5-0	31-32	90-95	2-3 days
Blood orange	4-7	40-44	90-95	3-8 weeks
Blueberries	-0.5-0	31-32	90-95	2 weeks
Bok choy	0	32	95-100	3 weeks
Boniato	13-15	55-60	85-90	4-5 months
Breadfruit	13-15	55-60	85-90	2-6 weeks
Broccoli	0	32	95-100	10-14 days
Brussels sprouts	0	32	95-100	3-5 weeks
Cabbage, early	0	32	98-100	3-6 weeks
Cabbage, late	0	32	98-100	5-6 months
Cactus Leaves	2-4	36-40	90-95	3 weeks
Cactus Pear	2-4	36-40	90-95	3 weeks
Caimito	3	38	90	3 weeks
Calabaza	10-13	50-55	50-70	2-3 months
Calamondin	9-10	48-50	90	2 weeks
Canistel	13-15	55-60	85-90	3 weeks
Cantaloups (3/4-slip)	2-5	36-41	95	15 days
Cantaloups (full-slip)	0-2	32-36	95	5-14 days
Carambola	9-10	48-50	85-90	3-4 weeks
Carrots, bunched	0	32	95-100	2 weeks
Carrots, mature	0	32	98-100	7-9 months
Carrots, immature	0	32	98-100	4-6 weeks
Cashew apple	0-2	32-36	85-90	5 weeks
Cauliflower	0	32	95-98	3-4 weeks
Celeriac	0	32	97-99	6-8 months
Celery	0	32	98-100	2-3 months
Chard	0	32	95-100	10-14 days
Chayote squash	7	45	85-90	4-6 weeks

Table 10: Recommended temperature and relative humidity, and approximate transit and storage life for fruits and vegetables—Continued

Product	Temperature		Relative Humidity (percent)	Approximate storage life
	°C	°F		
Cherimoya	13	55	90-95	2-4 weeks
Cherries, sour	0	32	90-95	3-7 days
Cherries, sweet	-1 to -0.5	30-31	90-95	2-3 weeks
Chinese broccoli	0	32	95-100	10-14 days
Chinese cabbage	0	32	95-100	2-3 months
Chinese long bean	4-7	40-45	90-95	7-10 days
Clementine	4	40	90-95	2-4 weeks
Coconuts	0-1.5	32-35	80-85	1-2 months
Collards	0	32	95-100	10-14 days
Corn, sweet	0	32	95-98	5-8 days
Cranberries	2-4	36-40	90-95	2-4 months
Cucumbers	10-13	50-55	95	10-14 days
Currants	-0.5-0	31-32	90-95	1-4 weeks
Custard apples	5-7	41-45	85-90	4-6 weeks
Daikon	0-1	32-34	95-100	4 months
Dates	-18 or 0	0 or 32	75	6-12 months
Dewberries	-0.5-0	31-32	90-95	2-3 days
Durian	4-6	39-42	85-90	6-8 weeks
Eggplants	12	54	90-95	1 week
Elderberries	-0.5-0	31-32	90-95	1-2 weeks
Endive and escarole	0	32	95-100	2-3 weeks
Feijoa	5-10	41-50	90	2-3 weeks
Figs, fresh	-0.5-0	31-32	85-90	7-10 days
Garlic	0	32	65-70	6-7 months
Ginger root	13	55	65	6 months
Gooseberries	-0.5-0	31-32	90-95	3-4 weeks
Granadilla	10	50	85-90	3-4 weeks
Grapefruit, Calif. & Ariz.	14-15	58-60	85-90	6-8 weeks
Grapefruit, Fla. & Texas	10-15	50-60	85-90	6-8 weeks
Grapes, Vinifera	-1 to -0.5	30-31	90-95	1-6 months
Grapes, American	-0.5-0	31-32	85	2-8 weeks
Greens, leafy	0	32	95-100	10-14 days
Guavas	5-10	41-50	90	2-3 weeks
Haricot vert	4-7	40-45	95	7-10 days
Horseradish	-1-0	30-32	98-100	10-12 months
Jaboticaba	13-15	55-60	90-95	2-3 days
Jackfruit	13	55	85-90	2-6 weeks
Jaffa orange	8-10	46-50	85-90	8-12 weeks
Japanese eggplant	8-12	46-54	90-95	1 week
Jerusalem Artichoke	-0.5-0	31-32	90-95	4-5 months
Jicama	13-18	55-65	65-70	1-2 months
Kale	0	32	95-100	2-3 weeks
Kiwano	10-15	50-60	90	6 months
Kiwifruit	0	32	90-95	3-5 months
Kohlrabi	0	32	98-100	2-3 months
Kumquats	4	40	90-95	2-4 weeks
Langsat	11-14	52-58	85-90	2 weeks
Leeks	0	32	95-100	2-3 months
Lemons	10-13	50-55	85-90	1-6 months
Lettuce	0	32	98-100	2-3 weeks
Limes	9-10	48-50	85-90	6-8 weeks

Table 10: Recommended temperature and relative humidity, and approximate transit and storage life for fruits and vegetables—Continued

Product	Temperature		Relative Humidity (percent)	Approximate storage life
	°C	°F		
Lo bok	0-1.5	32-35	95-100	2-4 months
Loganberries	-0.5-0	31-32	90-95	2-3 days
Longan	1.5	35	90-95	3-5 weeks
Loquats	0	32	90	3 weeks
Lychees	1.5	35	90-95	3-5 weeks
Malanga	7	45	70-80	3 months
Mamey	13-15	55-60	90-95	2-6 weeks
Mangoes	13	55	85-90	2-3 weeks
Mangosteen	13	55	85-90	2-4 weeks
Melons:				
Casaba	10	50	90-95	3 weeks
Crenshaw	7	45	90-95	2 weeks
Honeydew	7	45	90-95	3 weeks
Persian	7	45	90-95	2 weeks
Mushrooms	0	32	95	3-4 days
Nectarines	-0.5-0	31-32	90-95	2-4 weeks
Okra	7-10	45-50	90-95	7-10 days
Olives, fresh	5-10	41-50	85-90	4-6 weeks
Onions, green	0	32	95-100	3-4 weeks
Onions, dry	0	32	65-70	1-8 months
Onion sets	0	32	65-70	6-8 months
Oranges, Calif. & Ariz.	3-9	38-48	85-90	3-8 weeks
Oranges, Fla. & Texas	0-1	32-34	85-90	8-12 weeks
Papayas	7-13	45-55	85-90	1-3 weeks
Passionfruit	7-10	45-50	85-90	3-5 weeks
Parsley	0	32	95-100	2-2.5 months
Parsnips	0	32	95-100	4-6 months
Peaches	-0.5-0	31-32	90-95	2-4 weeks
Pears	-1.5 to -0.5	29-31	90-95	2-7 months
Peas, green	0	32	95-98	1-2 weeks
Peas, southern	4-5	40-41	95	6-8 days
Pepino	4	40	85-90	1 month
Peppers, Chili (dry)	0-10	32-50	60-70	6 months
Peppers, sweet	7-13	45-55	90-95	2-3 weeks
Persimmons, Japanese	-1	30	90	3-4 months
Pineapples	7-13	45-55	85-90	2-4 weeks
Plantain	13-14	55-58	90-95	1-5 weeks
Plums and prunes	-0.5-0	31-32	90-95	2-5 weeks
Pomegranates	5	41	90-95	2-3 months
Potatoes, early crop	10-16	50-60	90-95	10-14 days
Potatoes, late crop	4.5-13	40-55	90-95	5-10 months
Pummelo	7-9	45-48	85-90	12 weeks
Pumpkins	10-13	50-55	50-70	2-3 months
Quinces	-0.5-0	31-32	90	2-3 months
Raddichio	0-1	32-34	95-100	2-3 weeks
Radishes, spring	0	32	95-100	3-4 weeks
Radishes, winter	0	32	95-100	2-4 months
Rambutan	12	54	90-95	1-3 weeks
Raspberries	-0.5-0	31-32	90-95	2-3 days
Rhubarb	0	32	95-100	2-4 weeks
Rutabagas	0	32	98-100	4-6 months

Table 10: Recommended temperature and relative humidity, and approximate transit and storage life for fruits and vegetables—Continued

Product	Temperature		Relative Humidity (percent)	Approximate storage life
	°C	°F		
Salsify	0	32	95-98	2-4 months
Santol	7-9	45-48	85-90	3 weeks
Sapodilla	16-20	60-68	85-90	2-3 weeks
Scorzonera	0-1	32-34	95-98	6 months
Seedless cucumbers	10-13	50-55	85-90	10-14 days
Snow peas	0-1	32-34	90-95	1-2 weeks
Soursop	13	55	85-90	1-2 weeks
Spinach	0	32	95-100	10-14 days
Squashes, summer	5-10	41-50	95	1-2 weeks
Squashes, winter	10	50	50-70	2-3 months
Strawberries	0	32	90-95	5-7 days
Sugar apples	7	45	85-90	4 weeks
Sweetpotatoes	13-15	55-60	85-90	4-7 months
Tamarillos	3-4	37-40	85-95	10 weeks
Tamarinds	7	45	90-95	3-4 weeks
Tangerines, mandarins, and related citrus fruits	4	40	90-95	2-4 weeks
Taro root	7-10	45-50	85-90	4-5 months
Tomatillos	13-15	55-60	85-90	3 weeks
Tomatoes, mature-green	18-22	65-72	90-95	1-3 weeks
Tomatoes, firm-ripe	13-15	55-60	90-95	4-7 days
Turnips	0	32	95	4-5 months
Turnip greens	0	32	95-100	10-14 days
Ugli fruit	4	40	90-95	2-3 weeks
Waterchestnuts	0-2	32-36	98-100	1-2 months
Watercress	0	32	95-100	2-3 weeks
Watermelons	10-15	50-60	90	2-3 weeks
White sapote	19-21	67-70	85-90	2-3 weeks
White asparagus	0-2	32-36	95-100	2-3 weeks
Winged bean	10	50	90	4 weeks
Yams	16	61	70-80	6-7 months
Yucca root	0-5	32-41	85-90	1-2 months

Sources: largely from Hardenburg, Watada, and Wang (7), also from Buishand, Houwing, and Jansen (3), Martin (11), Maxwell and Maxwell (12),(13), Ortho Books (15), Pantastico (17), Pijpers, Constant, and Jansen (18), The Packer (16), Produce Marketing Association (20), Safeway Stores, Inc. (25), United Fresh Fruit and Vegetable Association (30). Information also was obtained from J.R. Brooks & Son, Inc. and Frieda's Finest Produce Specialties, Inc.

Potted Flowering and Foliage Plants

The market for flowering potted plants and potted foliage plants has grown rapidly. These plants are often shipped long distances, for eventual placement in shopping malls, restaurants, offices and homes. During transportation, plants need protection from temperature extremes, moisture loss, bruising, insects, disease, and ethylene.

Cuttings

Rooted and unrooted cuttings are exported for potting and growing in greenhouses and then transported for sale in domestic and foreign markets for eventual placement in office, store, restaurant, or home interiors. The purpose of shipping this plant material in the form of cuttings is to comply with buyer specifications or, in the case of the United States, restrictions on the importation of soil under Quarantine 37. The restrictions are necessary to prevent harmful insects and diseases from entering the United States. Shippers and importers should check with APHIS for current information that may apply to their products. Almost all plant material requires a permit to enter the United States. Most other countries also require permits and certificates.

Cuttings should be washed, sprayed with a U.S. approved fungicide and insecticide when necessary, and coated with a preservative wax based solution to retard moisture loss. Cuttings and other nursery stock can be packed in any of the USDA approved packing materials listed below:

buckwheat hulls	perlite
coral sand from Bermuda, when certified	polymer stabilized cellulose
excelsior	quarry gravel
exfoliated vermiculite	sawdust
ground cork	shavings-wood or cork
ground peat	sphagnum moss
ground rubber	vegetable fiber free of pulp, except sugar cane or cotton fiber
paper	

In addition to any of the above packing materials, cuttings should be wrapped in newspaper to provide insulation and moisture retention and placed in a strong one-piece or full telescoping waxed fiberboard box, lined with polyethylene film. When shipping to areas with extremely hot or cold weather, the box can be lined with polystyrene foam. The box should be sized to fit on a standard 1219 x 1016 mm (48 x 40 in) pallet. Banana boxes are popular with some shippers.

Temperatures between 15 to 18°C (60-65°F) at 85-90% relative humidity should be maintained during transportation and storage of most cuttings. Cuttings usually are transported by air cargo when they are exported. Some plants may benefit from acclimatization prior to being shipped. This process is described for potted plants.

Treatments

Potted plants require careful handling before, during, and after transportation. Researchers have shown that the potted foliage plants benefit when the following adjustments are made before packaging and transportation:

- light—high light levels should be reduced by 75% over a 5 week period.
- watering—soil should be moist, with water content at 50% of soil capacity during transportation. Soil that is too moist may damage packaging and lead to diseases, while soil that is too dry will injure plant tissues and lead to a loss of leaves. Plants should be watered one day before shipping.
- fertilization—initial fertilizer rates should be reduced by 25-30% over a period of 1 month. No fertilizer should be applied within 1 week of shipping.

These adjustments help acclimate plants to darkness in trailers and van containers as well as low light levels in building and home interiors.

Plants that are not properly acclimated will suffer a large loss of leaves or chilling injury. Many plants are placed in greenhouses for 1 to 3 months after being transported long distances, to regain their vigor or finish growing. Severely injured plants, however, will not recover.

Packaging

The choice of packaging is based on the size of the plant, the amount of foliage, the flexibility of the branches and leaves, as well as their tendency to become entangled or damaged during loading. Freight rates and desired loading density are additional factors to be considered.

In deciding the amount of packaging and subsequent loading procedures, shippers should keep in mind that unprotected plants are subject to cold air and the possibility of being damaged and bruised. Damaged plants produce more ethylene, which causes leaves to yellow, drop, or curl downward. Flowers on plants affected by ethylene will fail to open, wilt, or fall off.

Plants must never be shipped or stored with fruits, vegetables, or cut flowers as these products also give off ethylene. Flowering plants should be shipped separately from foliage plants. Flowers and fruit should be removed from plants transported overseas in van containers.

Most potted plants are protected during handling and transportation with kraft paper or clear plastic sleeves. Woven polyester sleeves also are available. The sleeves are designed to be grabbed at the top. This provides a means of quickly handling the plants. Large plants with pot diameters that are 430 mm (17 in) or greater are wrapped with plastic or paper.

Smaller plants also are placed in fiberboard boxes with dividers between plants and a moisture resistant tray at the bottom of the box. Polystyrene foam liners should be used when the plants are shipped to areas with extreme hot and cold weather. The boxes should be clearly labeled to show origin and destination and list the contents as live plants, fragile, and perishable. Temperature recommendations and arrows indicating "this end up" also should be marked on the box.

Boxes should be sized to fit on the standard 1219 x 1016 mm (48 x 40 in) pallet. The boxes can be unitized on the pallets and, if kept out of direct sunlight, covered with plastic film to reduce moisture loss and ethylene injury. Recommended standards for potted plant pack sizes and fiberboard box specifications have been developed by the Produce Marketing Association and the Society of American Florists. These are given in Table 11.

Table 11. Industry standards for potted plant pack sizes

Pot Diameter	Number of Pots
76 mm (3.0 in)	28
102 mm (4.0 in)	15
114 mm (4.5 in)	15
127 mm (5.0 in)	10
140 mm (5.5 in)	8
152 mm (6.0 in)	6
165 mm (6.5 in)	6
178 mm (7.0 in)	4
191 mm (7.5 in)	4
203 mm (8.0 in)	4
216 mm (8.5 in)	4
229 mm (9.0 in)	3
254 mm (10 in)	2
357 mm (14 in)	1

Materials

- Minimum 1724 kPa (250 lb/in²) bursting test fiberboard.
- 161 g/m² (33 lb/1000 ft²) corrugated medium.
- C Flute corrugation, 42 flutes per 0.3 m (linear ft), 3.5 mm (9/64 in) high.
- Waterproof adhesive.
- Fiberboard dividers for long distance transport or high relative humidity.
- Moisture resistant wax or plastic impregnated fiberboard tray.
- Cut-out hand grips for ease in handling.

Source: Society of American Florists and the Produce Marketing Association. (28).

Plants also are shipped in racks, trays, or "open," without sleeves or boxes in which case the plants are loaded directly on the trailer or van container floor. In domestic shipments, metal racks are sometimes used which provide a means to quickly roll the plants on and off trailers. The loaded racks can be covered with plastic film.

Molded polystyrene foam trays with legs also are available holding 36-100 pots ranging in diameter from 102-152 mm (4-6 in). The plants can be grown and shipped in these trays which are lightweight and stackable.

Regardless of the packing method, each plant should have a care and handling tag attached to ensure customer satisfaction. The information provided should include a color picture, common name, scientific name, recommended light level, water, and fertilizer requirements and recommended day and night temperatures.

Transportation

Bottom air delivery trailers and van containers with provisions for shelves, cargo straps, and load locks are recommended for shipping potted plants over long distances. Sleeved plants should be loaded in a pyramid or staggered style with the pot edges supporting the weight in stacks. Once half the height of the trailer has been reached, shelving should be installed to support additional plants. Boxed plants that are not palletized also may benefit from shelving which reduces the risk of damage from crushing.

Boxed, sleeved, and unpackaged plants should be braced with load lock bars, load gates or other wood bracing to keep them from falling and crushing. Large plants can be placed inside old tires for stability.

The general recommended temperature range for shipping potted plants is 15 to 18°C (60-65°F) at a relative humidity of 85-90%. Plants grown in the summer and shipped during warm months require warmer shipping temperatures. Lower than recommended temperatures for many plants will cause chilling injury. This leads to wilting and yellowing of the leaves. Higher than recommended temperatures will increase the amount of ethylene produced by the plant while lower humidities will dry out the plants. An air temperature recorder should be placed in every load to monitor the transit temperature.

Based on simulated transit research more specific temperature recommendations for 28 different foliage plants are given in Table 12. Information on brief storage periods are given for many potted plants in Table 13. Plants which cannot tolerate dark storage conditions must be unpacked immediately, watered as necessary and held in lighted conditions at 18-24°C (65-75°F). All plants should be protected from cold drafts.

Table 12. Suggested shipping temperatures for acclimatized foliage plants¹

Plant name	1-15 days' shipment		16-30 days' shipment ²	
	°C	°F	°C	°F
<i>Aglaonema</i> , cv. <i>Fransher</i>	13-16	55-60	16-18	60-65
<i>Aglaonema</i> , cv. <i>Silver Queen</i>	16-18	60-65	16-18	60-65
<i>Ardisia crispa</i>	10-13	50-55	—	—
<i>Aspidistra elatior</i>	10-13	50-55	—	—
<i>Brassaia actinophylla</i>	10-13	50-55	10-13	50-55
<i>Chamaedorea elegans</i>	13-16	55-60	—	—
<i>Chamaedorea seifrizii</i>	13-16	55-60	—	—
<i>Chrysalidocarpus lutescens</i>	13-18	55-65	16-18	60-65
<i>Codiaeum variegatum</i>	16-18	60-65	16-18	60-65
<i>Cordyline terminalis</i>	16-18	60-65	—	—
<i>Dieffenbachia picta</i>	16-18	60-65	—	—
<i>Dracaena deremensis</i>	16-18	60-65	—	—
<i>Dracaena fragrans</i>	16-18	60-65	—	—
<i>Dracaena marginata</i>	13-18	55-65	16-18	60-65
<i>Ficus bengamina</i>	13-16	55-60	13-16	55-60
<i>Ficus nitida</i>	13-16	55-60	—	—
<i>Howeia forsteriana</i>	10-18	50-65	10-18	50-65
<i>Nephrolepis exaltata</i>	16-18	60-65	—	—
<i>Peperomia bicolor</i>	16-18	60-65	—	—
<i>Philodendron selloum</i>	13-16	55-60	—	—
<i>Philodendron oxycardium</i>	16-18	60-65	—	—
<i>Phoenix roebelenii</i>	10-13	50-55	—	—
<i>Pleomele reflexa</i>	16-18	60-65	—	—
<i>Rhapis excelsa</i>	10-13	50-55	—	—
<i>Shefflera arboricola</i>	10-13	50-55	10-13	50-55
<i>Scindapsus aureus</i>	16-18	60-65	—	—
<i>Spathiphyllum</i> , <i>Mauna Loa</i>	10-13	50-55	13-16	55-60
<i>Yucca elephantipes</i>	10-13	50-55	10-13	50-55

¹Data are for plants in containers in the dark. Some plants stored without lights for 10 to 14 days will show slight to severe leaf loss and/or yellowing but will recover.

²Blanks indicate that plant's tolerance to shipping beyond 15 days is unknown.

Source: Hardenburg, Watada, and Wang (7).

Table 13. Recommended temperature, relative humidity and storage period for potted plants not acclimated to darkness

Common name/ Scientific name(s)	Temperature		Relative Humidity (Percent)	Storage Period
	°C	°F		
AFRICAN VIOLET <i>Sainpaulia ionanatha</i>	21-24	70-75		*
AGLAONEMA <i>Aglaonema</i> spp.	16-21	60-70	65-85	10 days
ASPARAGUS <i>Asparagus densiflorus sprengeri</i> <i>Asparagus setaceus</i>	18-21	65-75		*
AZALEA <i>Rhododendron</i> hybrid	16	60		3 days
BEGONIA <i>Begonia</i> × <i>hiemalis</i>	16-21	60-70		*
BROMELIADS <i>Aechmea fasciata</i> <i>Neoregelia carolinæ tricolor</i>	21-27	70-80		*
CHRYSANTHEMUM <i>Chrysanthemum morifolium</i>	2	35	80-90	5 days
CYCLAMEN <i>Cyclamen persicum giganteum</i>	10	50	80-90	4 days
DIEFFENBACHIA <i>Dieffenbachia</i> spp.	16-21	60-70		5 days
DRACAENA <i>Dracaena</i> spp. <i>Cordyline terminalis</i>	16-24	60-75		7 days
EASTER LILY <i>Lilium longiflorum</i> , flower buds puffy, white, unopened.	0-3	32-37		14 days
FERNS <i>Nephrolepis</i> spp. <i>Adiantum raddianum</i> <i>Asplenium nidus</i> <i>Pteris cretica</i> <i>Pteris ensiformis</i>	16-24	60-75	75-85	7 days
FICUS <i>Ficus</i> spp.	13-21	55-70	65-85	7 days
GLOXINA <i>Sinningia speciosa</i>	16	60	70-90	4 days
HIBISCUS <i>Hibiscus rosa-sinensis</i>	18-24	65-75		*
KALANCHOE <i>Kalanchoe blossfeldiana</i>	16	60		4 days

Table 13. Recommended temperature, relative humidity and storage period for potted plants not acclimated to darkness—Continued

Common name/ Scientific name(s)	Temperature		Relative Humidity (Percent)	Storage Period
	°C	°F		
PALM	10-21	50-70	65-75	10 days
<i>Chrysalidocarpus lutescens</i>				
<i>Chamaedorea erumpens</i>				
<i>Chamaedorea elagans</i>				
<i>Howeia forsteriana</i>				
<i>Phoenix roebelenii</i>				
PEPEROMIA	16-24	60-75	65-85	7 days
<i>Peperomia</i> spp.				
PHILODENDREN	16-24	60-75	65-85	7 days
<i>Philodendron</i> spp.				
POINSETTA	10-12	50-54		4 days
<i>Euphorbia pulcherrima</i>				
POTHOS	16-24	60-75	65-85	7 days
<i>Scindapsus aureus</i>				
ROSES	1-3	34-37		5 days
<i>Rosa hybrida</i>				
SCHEFFLERA	13-18	55-65		7 days
<i>Brassaia actinophylla</i>				
<i>Brassaia arboracola</i>				

* These plants cannot be stored in darkness at lower temperatures.

Source: Society of American Florists (27) except data on Easter lilies and roses from Hardenburg, Watada, and Wang (7).

Sources for the preceding product guidelines are: Conover and Poole (4), Hardenburg, Watada, and Wang (7), Langefeld (9), Poole and Conover (19), Society of American Florists (27).

Cut Flowers and Florist Greens

The market for cut flowers is growing, especially for the more exotic flowers. Flowers are very perishable. Quality must be very high to ensure time for distribution, consumer acceptance, and repeat purchases. Maintenance of quality requires careful handling from harvest to display in the consumers home. The Society of American Florists (27) has developed important guidelines in this regard.

Treatments

Cut flowers are harvested at various stages of maturity, depending on the cultivar and buyer specifications. Asters, bird-of-paradise, carnations, chrysanthemums, gladioli, iris, roses, and snapdragons are harvested in the tight-bud stage to extend shelf life. Other flowers, such as orchids must be fully developed before being cut. Damaged and diseased flowers must be immediately discarded as they produce ethylene and spread decay, ruining healthy flowers.

One of the most important steps in postharvest treatment of cut flowers is to recut the flower stems at an angle under warm 38° to 44°C (100-110°F) water and place them in a plastic container filled with 100-150 mm (4-6 in) of floral preservative solution of the same temperature. At least 25 mm (1 in) of stem should be removed as well as foliage that would be below the water line in the container. Foliage in water will decay, causing damage to the flowers.

Typical solutions contain 1% sugar, a biocide (200 ppm 8-HQC, 8-HQS, or Phytan-20; or 50 ppm silver nitrate) and an acidifier (200-600 ppm citric acid or aluminum sulfate; 10-20 ppm when silver nitrate is used). The sugar replaces the stored foods consumed by respiration, while biocides limit bacteria which plug up flower stems. Acidifiers aid in the uptake of water by reducing the pH to 3.5-4.5.

The water used in the solutions must be high quality, low in alkalinity and salinity or total dissolved solids (less than 200 ppm). Deionized water is recommended. Fluoride found in most tap water will damage gladioli and gerbera.

Hormones and growth regulators, such as N-6 benzyladenine at 10-20 ppm, are occasionally added to floral preservative solutions. Wetting agents to aid in water uptake, such as sodium hypochlorite at 4 ppm or 0.1% bleach, also may be added.

Floral preservative solutions should be used at each stage of distribution; by the grower, after storage and prior to shipment, and by the wholesaler, retailer, and consumer after the flowers are received. The solutions can either double or triple the shelf life of many flowers. Some florist greens, which have a longer shelf life to begin with, also benefit from floral preservative. These include boxwood, leather-leaf fern, camellia, eucalyptus, ivy, scotch broom, and podocarpus. In addition to floral preservative solution, special solutions are used by growers, wholesalers, or retailers to achieve beneficial effects.

Pulsing solutions containing 10-20% sugar are used for 16-24 hours by growers prior to packaging and transportation to extend shelf life and assist in subsequent opening of carnations, chrysanthemums, gladiola, gypsophila, roses, and bird-of-paradise flowers. Pulsing also is done by some wholesalers.

Bud-opening solutions containing 1.5-2.0% sugar, 200 ppm biocide, and 75-100 ppm acidifier are used at room temperature and high humidity by growers, wholesalers, or retailers for flowers cut in the tight-bud stage. After the flowers open, they should be returned to the recommended storage temperature.

Hydrating solutions containing 200-600 ppm acidifier and 0.1% wetting agent are used for 1 to 2 hours to increase the uptake of water by flowers such as roses. These solutions are used by growers, wholesalers, and retailers.

Silver thiosulfate (STS) conditioning solutions with silver nitrate are used by growers for 1 hour on dry flowers and 2 hours on flowers previously in water to protect them from ethylene damage. Alstroemeria, anemone, carnations, delphinium, freesia, gypsophila, enchantment lily, and snapdragon benefit from STS conditioning. Gerbera, iris, rubrum lily, orchids, star-of-Bethlehem, and tulips also may benefit. All of these flowers should be held away from chrysanthemums, which produce a lot of ethylene. STS should not be applied more than once. Wholesalers or retailers may apply it if the grower has not.

Packaging

Depending on flower size, desired appearance, or buyer specifications, flowers are bunched with 10, 25 or more blooms per bunch. Gypsophila, lilies-of-the-valley, miniature carnations, pompon chrysanthemums, spray type orchids, statice, and stevia are handled in this manner. Bunches are tied or banded loosely to avoid damage. They are also wrapped in moisture resistant paper, wet newspaper, or placed in clear plastic sleeves.

Flowers are packed in bulk or by count, the total amount depending on the box size and customer order. A 1040 x 510 x 180 mm (41 x 20 x 7 in) box for example is generally packed with 500-600 carnations, 250-300 roses, or 35-40 bunches of pompom chrysanthemums, 10 blooms per bunch.

Individual stems such as bird-of-paradise or chrysanthemum or bunches of stems such as freesia and tulips are have their flowers protected with plastic netting or sleeves. More specialized packaging, utilizing fiberboard, has been developed for anthuriums and gerberas to protect the flower heads and hold the stems straight. Orchids with solitary blooms are packed in shredded polyester fiber. The stem ends are placed in small glass vials filled with floral preservative solution. The vials are taped to the bottom of the box. Tissue paper is used to protect flowers sensitive to condensation such as carnations and daffodils.

Most flowers are packed in full telescoping fiberboard boxes lined with polyethylene film or moisture resistant paper to maintain high humidity. Corrugated plastic boxes and wirebound wood crates also are used by some shippers. Roses are packed in polystyrene foam boxes or fiberboard boxes which are lined with either polystyrene foam or polyurethane foam, for insulation from extreme hot or cold temperatures.

Individual flowers or bunches of flowers are carefully placed in the boxes in alternating layers until the box is filled to the desired capacity without bruising or crushing. Paper padding is used between layers. Plastic liners and moistened shredded paper are used to cushion exotic flowers such as anthuriums, bird-of-paradise, heliconia, and red ginger and provide high humidity.

Mixed boxes of flowers that are compatible in temperature requirements are packed for retailers selling a limited volume of special or exotic flowers. Heavier flowers should be individually wrapped and placed on the bottom of the box. More fragile flowers should be placed on top. All boxes of flowers should be full, as filled boxes have a higher humidity.

Flowers are secured in boxes with 1 or 2 strips of wood wrapped with paper or a piece of polystyrene fastened to the sides of the box. The wood cleats are nailed between the sides of the box. Bottle caps are used on the outside of the box to prevent the nail from pulling through. Once the flowers are secured they may be covered with additional newspaper or plastic. The box cover is then secured with string or plastic strapping.

Roses are often packed with ice in plastic bags or gel pack. Roses also are packed "wet" in boxes with floral preservative solutions secured at the bottom of the box. In this case the roses are packed and stored vertically. Wet pack also is used for circium, gerberas, gypsophila, larkspur, lilies, mini-carnations, and mixed bouquets.

Wet packing is primarily restricted to flowers transported by highway trailer. Many airlines restrict the use of ice and water. Those that permit ice, require that it be packed in bags in leak-proof containers, utilizing polystyrene foam or polyethylene film.

Some flowers must be packed, or stored and transported vertically to prevent geotropic bending in which the plant tip orients itself away from the center of gravity. This is true for anemone, calendula, daffodils, freesia, gladioli, ranunculus, and snapdragon which will curve upward when placed horizontally.

Florist greens are sometimes package-iced, in wax impregnated or polyethylene film lined fiberboard boxes. Wet newspaper or waxed paper also are used to provide high humidity.

The Society of American Florists and the Produce Marketing Association have recommended standard fiberboard box sizes to reduce the large number of various containers and packs, provide better stacking and utilization of the standard 1219 x 1016 mm (48 x 40 in) pallet, and increase overall efficiency in distribution. These recommendations are given in Table 14.

Table 14. Industry standards for cut flower boxes

Inches			Outside Dimensions	Centimeters						
L	W	H		L	W	H				
41	x	5	x	7*	104	x	12.5	x	18	
41	x	10	x	7**	104	x	25.5	x	18	
41	x	20	x	7	104	x	51	x	18	
44	x	5	x	8*	112	x	12.5	x	20.5	
44	x	10	x	8**	112	x	25.5	x	20.5	
44	x	20	x	8	112	x	51	x	20.5	
44	x	10	x	6*	112	x	25.5	x	15	
44	x	20	x	6**	112	x	51	x	15	
44	x	20	x	12	112	x	51	x	30.5	
48	x	10	x	6*	122	x	25.5	x	15	
48	x	20	x	6**	122	x	51	x	15	
48	x	20	x	12	122	x	51	x	30.5	
13	x	7	x	48**	(Gladioli)	33	x	18	x	122
13	x	13	x	48	(Gladioli)	33	x	33	x	122
40	x	16	x	4	(Gerbera)	101.5	x	40.5	x	10
41	x	22	x	17.25	(Gerbera)	104	x	53	x	44
30	x	14	x	9**	(Greens)	76	x	35.5	x	23
30	x	14	x	15	(Greens)	76	x	35.5	x	38
13	x	13	x	24	(Iris, Gypsophila)	33	x	33	x	61
13	x	13	x	22	(Wet Pack Roses)	33	x	33	x	56
23	x	18	x	17.5	(Daisy)	58.5	x	45.5	x	44.5

*Quarter Box **Half Box,

Centimeter dimensions are approximate

Materials

- Minimum 1724 kPa (250 lb/in²) bursting strength fiberboard.
- 337 g/m² (69 lb/1000 ft²) weight outer liner.
- 161 g/m² (33 lb/1000 ft²) weight corrugated medium.
- 205 g/m² (42 lb/1000 ft²) weight inner liner.
- C Flute corrugation, 42 flutes per 0.3 m (linear ft), 3.5 mm (9/64 in) high.
- water repellent wax inner liner for wet product.
- Waterproof adhesive.
- Properly stapled.

Source: Society of American Florists and the Produce Marketing Association (28).

Refrigeration

Precooling and refrigerated storage of cut flowers and florist greens in high humidity are equally important in maintaining the quality of cut flowers. Precooling should be done as soon as possible after harvest, either before, during or after treatment with floral preservative solutions. Flowers can be placed in a refrigerated room while undergoing treatment, except in the case of bud-opening solutions, which require the flowers to be held at room temperature.

Some flowers are stored dry by growers for brief periods until sufficient quantities are available for shipment during special holidays. Precooling is essential before the flowers are placed vertically in closed film lined or wax impregnated fiberboard drums for storage. When placed in fiberboard boxes, the flowers can be precooled immediately after packing, provided sufficient holes are in the box ends or sides to ventilate field and product heat.

Low cost forced air precooling equipment has been developed to quickly cool boxed flowers in refrigerated rooms. The equipment consists of a portable exhaust fan which draws refrigerated air thru the boxes stacked on either side of an aisle in front of the fan. A canvas or plastic tarp is extended across the top of the boxes to the floor enclosing the aisle. The holes in the ends of the boxes must not be blocked by the flower packing materials. Forced air precooling can be accomplished in an hour, while room cooling of packaged flowers can take 24 hours or more, reducing shelf life.

All flowers should be precooled, stored and transported at their recommended storage temperatures. These are given in Table 15 at the end of this section. Some flowers and florist greens are tropical in origin and are very sensitive to chilling injury if held or transported at lower temperatures. These tropicals and other chill sensitive flowers and florist greens include:

anthurium	ginger	chamaedora
bird-of-paradise	godetia	cordyline (ti)
camellia	heliconia	differnbachia
cattleya orchid	poinsetta	palm
eucharis	protea	staghorn fern
euphorbia	vanda orchid	

Transportation

Air cargo is used for the export of cut flowers. Most of the flowers are shipped without refrigeration. This can reduce their shelf life. Fortunately most air transit times are short—a matter of hours. Minimizing product loss requires the use of protective packaging, precooling before loading, close coordination at origin and destination airports, and utilization of cold storage facilities near the airport. Flowers should not remain on the runway in sunlight or be held in unrefrigerated storage prior to official inspections or pickup by the receiver.

Boxes of cut flowers are unitized on air cargo pallets. Plastic strapping around the boxes is recommended to protect the pallet load. The pallets are then secured with the air cargo pallet netting. Some flowers also are transported in air cargo containers.

Refrigerated van containers are used for the export of florist greens. With adequate precooling, the florist greens can withstand transit times of 2 to 3 weeks.

Land transportation of cut flowers and florist greens is handled primarily by refrigerated highway trailers. The trailers are either loaded by hand or with pallet jacks. Some carriers have installed metal supports on the sidewalls of trailers for wood shelving. This helps to reduce crushing and damage of flowers on the bottom of hand-loaded stacks.

Most trailers make multiple stops as wholesalers prefer to receive small quantities several times a week. The goal is to minimize inventory and time in storage and maximize the freshness of the flowers in the hands of consumers.

Flowers and florist greens are shipped in mixed loads. Mixed loads of cut flowers can create a handling challenge when tropical items sensitive to chilling injury are included. Some carriers place these items in the cab of their tractor-trailer. In this case, however, they are held at higher than recommended temperatures. With increased volumes of tropical flowers, carriers may consider using multitemperature trailers, bulkheads, or insulated coverings or boxes to protect the flowers from colder temperatures.

Flowers and florist greens must never be shipped or stored with fruits or vegetables. Ideally, florist greens should be handled separately from flowers, as the florist greens are more sensitive to ethylene, which flowers produce in small amounts.

Storage

Fruits, vegetables, damaged or diseased flowers, flowers held at higher than recommended temperatures, as well as exhaust gases, produce ethylene which will cause downward bending of flower foliage, failure of buds to open, or open flowers to close or fall off. Florist greens will yellow, and leaves and berries will bend downward or fall off in the presence of ethylene. Damaged or diseased plant material also give off ethylene. Temperature control, ventilation, sanitation, and ethylene absorbent pads are used to minimize damage to flowers and florist greens in transit and storage.

Sources for the preceding product guidelines are: Hardenburg, Watada, and Wang (7), and Society of American Florists (27).

Table 15: Recommended temperature, relative humidity, and approximate transit and storage period for cut flowers and florist greens.

Commodity	Storage temperature		Approximate storage period ¹
	°C	°F	
Cut flowers ²			
Acacia	4	40	3-4 days
Alstroemeria	4	40	2-3 days
Allium	0-2	32-35	2 weeks
Anemone	4-7	40-45	2 days
Anthurium ⁴	13	56	2-4 weeks
Aster, China	0-4	32-40	1-3 weeks
Bird-of-paradise	7-8	45-46	1-3 weeks
Bouvardia	0-2	32-35	1 week
Buddleia	4	40	1-2 days
Calendula	4	40	3-6 days
Calla	4	40	1 week
Camellia ⁵	7	45	3-6 days
Candytuft	4	40	3 days
Carnation	-0.5-0	31-32	3-4 weeks
Carnation buds	-0.5-0	31-32	4-12 weeks
Carnation, miniature	-0.5-0	31-32	2 weeks
Chrysanthemum	-0.5-0	31-32	3-4 weeks
Clarkia	4	40	3 days
Columbine	4	40	2 days
Coreopsis	4	40	3-4 days
Cornflower	4	40	3 days
Cosmos	4	40	3-4 days
Crocus	0.5-2	33-36	1-2 weeks
Dahlia	4	40	3-5 days
Daisy, English	4	40	3 days
Daisy, Marguerite	2	36	1-2 weeks
Daisy, Shasta	4	40	7-8 days
Delphinium	4	40	1-2 days
Eucharis ⁵	7-10	45-50	7-10 days
Feverfew	4	40	3 days
Forget-me-not	4	40	1-2 days
Foxglove	4	40	1-2 days
Freesia	0-0.5	32-33	10-14 days
Gaillardia	4	40	3 days
Gardenia ⁵	0-1	32-34	2 weeks
Gerbera	1-4	34-40	1-2 weeks
Ginger	13	55	4-7 days
Gladiolus	2-5	35-42	5-8 days
Gloriosa	4-7	40-45	4-7 days

See footnotes at end of table.

Table 15: Recommended temperature, relative humidity, and approximate transit and storage period for cut flowers and florist greens—Continued

Commodity	Storage temperature		Approximate storage period ¹
	°C	°F	
Godetia	10	50	1 week
Gypsophila	4	40	1-3 weeks
Heather	4	40	1-3 weeks
Heliconia	12	54	10 days
Hyacinth	0-0.5	32-33	2 weeks
Iris, bulbous	-0.5-0	31-32	1-2 weeks
Laceflower	4	40	3 days
Lilac, forced	4	40	4-6 days
Lily	0-1	32-34	2-3 weeks
Lily-of-the-valley	-0.5-0	31-32	2-3 weeks
Lupine	4	40	3 days
Marigolds	4	40	1-2 weeks
Mignonette	4	40	3-5 days
Narcissus	0-0.5	32-33	1-3 weeks
Orchid, cattelya ^{4,5}	7-10	45-50	2 weeks
Orchid, cymbidium	-0.5-4	31-40	2 weeks
Orchid, vanda	13	55	5 days
Orinthogalum	4	40	4-6 weeks
Poppy	4	40	3-5 days
Peony,tight buds	0-1	32-34	2-6 weeks
Phlox	4	40	1-3 days
Poinsettia	10-15	50-60	4-7 days
Primrose	4	40	1-2 days
Protea	4	40	7-10 days
Ranunculus	0-5	32-41	7-10 days
Rose (in preservative)	0.5-2	33-35	4-5 days
Rose (dry pack)	-0.5-0	31-32	2 weeks
Snapdragon	4	40	1-2 weeks
Snowdrop	4	40	2-4 days
Squill	0-0.5	32-33	2 weeks
Statice	2-4	35-40	3-4 weeks
Stephanotis ⁵	4	40	1 week
Stevia	4	40	3 days
Stock	4	40	3-5 days
Strawflower, fresh	2-4	35-40	3-4 weeks
Sweet pea	-0.5-0	31-32	2 weeks
Sweet-william	7	45	3-4 days
Tulip	-0.5-0	31-32	2-3 weeks
Violet	1-5	34-41	3-7 days
Zinnia	4	40	5-7 days

See footnotes at end table.

Table 15: Recommended temperature, relative humidity, and approximate transit and storage period for cut flowers and florist greens—Continued

Commodity	Storage temperature		Approximate storage period ¹
	°C	°F	
Florist greens (decorative foliage) ^{2,3}			
Adiantum (maidenhair)	0-4	32-40	
Asparagus (plumosa) ⁶	2-4	35-40	2-3 weeks
Asparagus (sprenger) ⁶	2-4	35-40	2-3 weeks
Buxus (boxwood)	2-4	35-40	---
Camellia	4	40	---
Cedar ⁶	0	32	---
Chamaedorea	7	45	2-3 weeks
Cordyline (ti)	7-10	45-50	2-3 weeks
Croton	2-4	35-40	---
Dieffenbachia	13	55	---
Dracaena	2-4	35-40	---
Dagger & wood ferns ⁶	0	32	2-3 months
Eucalyptus	2-4	35-40	1-3 weeks
Galax ⁶	0	32	---
Ground pine ⁶	0	32	---
Hedera	2-4	35-40	2-3 weeks
Ilex(holly) ⁶	0-4	32-40	3-5 weeks
Juniper	0	32	1-2 months
Leatherleaf (baker fern)	1-4	34-40	1-2 months
Leucothoe, drooping	2-4	35-40	---
Magnolia	2-4	35-40	2-4 weeks
Mistletoe	0	32	3-4 weeks
Mountain-laurel	0	32	2-4 weeks
Myrtus (myrtle)	2-4	35-40	---
Palm	7	45	---
Philodendron	2-4	35-40	---
Pittosporum	2-4	35-40	2-3 weeks
Podocarpus	7	45	---
Pothos	2-4	35-40	---
Rhododendron	0	32	2-4 weeks
Salal (lemon leaf) ⁶	0	32	2-3 weeks
Scotch-broom	4	40	2-3 weeks
Smilax, southern ⁶	4	40	---
Staghorn fern	13	55	---
Vaccinium (huckleberry) ⁶	0	32	1-4 weeks
Woodwardia fern	0-4	32-40	---

¹Storage periods given should allow satisfactory handling and keeping after removal from storage.

²High relative humidity of 90 to 95 percent recommended in refrigerated storage rooms for cut flowers and florist greens. Likely, some flowers for which temperature of 4° is recommended could be stored longer and safely at lower temperatures.

³At retail level, florist greens held at approximately 4° for only 1 or 2 weeks. Most stored with stems in water, except where noted otherwise.

⁴Stems of orchids and some anthuriums should be placed in vials of water. However, some orchids and anthuriums may be stored by dry-pack methods.

⁵Not placed in water for handling or storage but may be misted.

⁶Usually held in moisture-retentive shipping cases.

Source: Hardenburg, Watada, and Wang (7).

Appendix 1

U.S. Regulations and Sources of Information

Exporters of fruits, vegetables, plants, cut flowers, and other agricultural products must meet the requirements of the origin and destination countries. It is very important for importers and exporters to keep informed of the changes in various import/export laws administered by U.S. Government agencies and their foreign counterparts. These agencies can provide valuable advice and assistance. Following are the addresses of a contact point in each agency and an outline of the agencies functions:

Animal and Plant Health Inspection Service (APHIS):

U.S. Department of Agriculture
Plant Protection and Quarantine, Permit Unit
6505 Belcrest Road
Room 632
Hyattsville, Maryland 20782 USA
Telephone 301-436-8645

- issues permits to U.S. importers of foreign agricultural products. Almost all imported agricultural products require a permit.
- inspects all imported agricultural products at the first U.S. port of entry for harmful insects, diseases, and prohibited items.
- maintains for each country of the world, a separate list of their agricultural products approved for entry to the United States. These lists are subject to change as products are added or deleted. Call the above telephone number for the latest information on a specific product from a specific country.
- provides information on the import requirements of foreign countries, inspection services, and Federal Phytosanitary Certificates for U.S. exporters of plant and unprocessed plant products.
- supervises quarantine treatments of imported and exported produce.
- provides a preclearance program at the requesting foreign country's expense in which products are inspected in the origin country prior to shipment to the United States.
- works with foreign countries on pest research and eradication programs.

Food and Drug Administration (FDA), U.S. Dept. of Health & Human Services:

International Affairs Staff
5600 Fishers Lane
Rockville, Maryland, 20857 USA
Telephone 301-443-4480

- inspects and enforces tolerance levels of pesticide and other contamination of all food products, fresh or processed, except for meat and poultry products, which are inspected by the USDA.
- provides single free copies of the publication: Action Levels for Poisonous or Deleterious Substances in Human Food and Animal Feed.

- enforces labeling requirements of consumer packages. The following information is required in English: name and address of manufacturer, packer or distributor, net amount of food in package in "English" units of measure, common or usual name of the food, and ingredients. The same information can be repeated in entirety in foreign languages and metric units.
- provides free copies of the publication: Information Materials for the Food and Cosmetic Industries. This lists other publications, many of which are available free.

Environmental Protection Agency (EPA)

Office of Pesticides and Toxic Substances
 Mail Stop 87508C
 Washington, D.C. 20460 USA
 Telephone 703-557-7410

- registers and reviews pesticides and establishes tolerances for residue levels in food.
- maintains a list of U.S. approved pesticides and tolerance levels.

Agricultural Marketing Service (AMS), U.S. Department of Agriculture

Information Staff
 Room 3510-S
 Washington, D.C. 20250 USA
 Telephone: 202-447-8998

- enforces marketing orders which apply at certain times of the year to domestic and imported avocados, dates, filberts, grapefruit, table grapes, kiwifruit, limes, canned ripe olives, onions, oranges, Irish potatoes, prunes, raisins, tomatoes, and walnuts. Importers and exporters should be aware that the scope and effective dates of these orders can change.
- enforces the Perishable Agricultural Commodities Act (PACA) which prohibits unfair and fraudulent practices in the marketing of fresh and frozen fruits and vegetables and sets penalties for violations. Commission merchants, dealers, and brokers handling these products in interstate or foreign commerce must be licensed. Growers, shippers, importers, exporters, and retailers should obtain some of the following publications:
 - The Perishable Agricultural Commodities Act, Fair Trading in the Fruit and Vegetable Industry
 - The Fruit and Vegetable Grower and PACA (AMS-591)
 - El Cultivador De Frutas Y Hortalizas Y El Decreto PACA (AMS-591-S)
 - What Food Retailers Should Know About the Perishable Agricultural Commodities Act (AMS-582)
 - Perishable Agricultural Commodities Act, 1930, and Regulations.
 - Rules of Practice Governing Formal Adjudicatory Administrative Proceedings Instituted by the Secretary.

- provides official grade standards for some fresh and processed fruits, vegetables, nuts, and related products. These standards are voluntary except in the case of products regulated by marketing orders. See Appendix 2 for a list of the grade standards and inspection instructions. Contact AMS for a list of the recently developed Market Inspection Instructions for Specialty Fresh Fruits and Vegetables.
- provides grading and inspection services at the requestor's expense at certain farms, terminal markets, and U.S. ports of entry.
- provides market news and reports on supplies, demand and prices in certain markets of the U.S. concerning fruits, vegetables, and ornamentals.
- inspects frozen or otherwise processed products under a verification program to meet the requirements of certain foreign countries.

U.S. Customs Service, U.S. Department of the Treasury

1301 Constitution Ave., N.W., Room 1315
 Washington, D.C. 20229 USA
 Telephone: 202-566-8068

- examines imported and exported products for proper documentation, labeling, and the assessment of duties, taxes, and fees.
- enforces the regulations of other U.S. Government agencies including those listed above.
- combats smuggling and other fraudulent activities.
- enforces import quotas.

Importers and exporters should obtain a copy of the the U.S. Customs Service publication—Importing Into the United States—from:

Superintendent of Documents
 Government Printing Office
 Washington, D.C. 20402 USA
 Telephone 202-783-3238 Enclose: \$4.25

Agricultural Research Service (ARS), U.S. Department of Agriculture

Information Staff
 Building 005, BARC-W, Room 307
 Beltsville, MD 20705
 Telephone: 301-344-2264

- conducts production research on plants and animals and postharvest research on plants.
- provides APHIS and EPA research results of treatments to combat harmful diseases and insects.

Persons needing more information on fruits, vegetables, plants, and flowers may contact ARS horticultural laboratories in the United States including Beltsville, Maryland; Miami, Florida; Orlando, Florida; Fresno, California; Hilo, Hawaii; Honolulu, Hawaii; and Mayaguez, Puerto Rico.

Foreign Agricultural Service (FAS), U.S. Department of Agriculture
Information Division
Room 5074-S
Washington, DC 20250
Telephone: 202-447-7115

- monitors world agriculture supply and demand and U.S. export sales.
- provides marketing assistance to U.S. agricultural exporters both within the United States and abroad through U.S. embassies and trade missions.
- implements programs to improve the competitiveness of U.S. exports such as the Export Enhancement Program and the Targeted Export Assistance Program.
- administers the Food for Peace (P.L. 480) foreign aid program.

Office of International Cooperation and Development (OICD):
U.S. Department of Agriculture
Private Sector Relations Division
Agribusiness Information Center
Washington, DC 20250-4300
Telephone 202-653-7911

- provides information on international agricultural trade, investment, marketing, as well as technical information through referrals.
- maintains an online data base, which can be accessed by telephone subscribers. Databases include TELENET, CARINET, CBIN, AGRIDATA, DIALCOM, EDI, and CRIS.

Office of Transportation (OT), U.S. Department of Agriculture
Washington, DC 20250-4500
Telephone 202-653-6275

- provides technical assistance on international and domestic agricultural transportation problems.
- conducts cooperative technical and economic research with industry and universities to improve the transportation of agricultural products.

National Agricultural Library (NAL), U.S. Department of Agriculture
Reference Desk
Beltsville, Maryland 20705 USA
Telephone: 301-344-4479

- provides agricultural information through on line computer data bases and lending of publications.
- coordinates information with U.S. State land grant college libraries and field libraries.
- serves as a center for international agricultural information.

Food Safety and Inspection Service (FSIS), U.S. Department of Agriculture
International Programs
Washington, D.C. 20250 USA
Telephone: 202-447-3473

- requires that countries exporting meat and poultry products to the United States have inspection systems at least equal to those required in the United States including residue testing and species verification.
- reviews foreign inspection systems and plants.
- approves labels.
- inspects all meat and poultry in the United States including those products which are exported.
- provides information on the import requirements of foreign countries.

Economic Research Service (ERS), U.S. Department of Agriculture
Economics Management Staff
1301 New York Ave., N.W.
Washington, D.C. 20005-4789 USA
Telephone: 202-786-1504

- conducts research in domestic and foreign agricultural economics.
- reports situation and outlook, commodity projections, price spreads, and analyses of U.S. farm commodity programs.

Appendix 2

U.S. Grade Standards Write: Fresh Products Branch; USDA-AMS, FV; Room 2056-S, Washington, DC, 20250, for single free copies of any of these standards.

Vegetables (Fresh Market)	Established	Amended
Anise, Sweet	1930	3/15/73
Artichokes, Globe	1926	5/15/69
Asparagus, Fresh	4/4/46	4/1/66
Beans, Lima	1/5/38	
Beans, Snap	8/1/36	
Beets	8/1/55	
Broccoli, Bunched Italian Sprouting	1930	7/12/43
Brussels Sprouts	1/18/54	
Cabbage	9/1/45	
Cantaloups	4/15/61	6/30/68
Carrots, Bunched	12/15/37	9/18/54
Carrots, Topped	1928	12/20/65
Carrots With Short Trimmed Tops	3/2/42	9/18/54
Cauliflower	8/7/39	3/15/68
Celery	8/15/46	4/7/59
Corn, Green	1927	5/18/54
Cucumbers	11/13/53	3/1/58
Cucumbers, Greenhouse	10/1/34	
Eggplant	12/1/33	10/29/53
Endive, Escarole or Chicory	10/1/64	
Garlic	9/4/44	
Greens, Beet	6/1/59	
Greens, Collard Or Broccoli	4/16/53	
Greens, Dandelion	2/4/55	
Greens, Mustard and Turnip	3/8/53	
Honeydew And Honey Ball Type Melons	5/20/37	4/1/67
Horseradish Roots	7/27/36	
Kale	4/25/34	
Lettuce	3/15/34	12/1/75
Lettuce, Greenhouse Leaf	10/1/34	9/1/64
Mushrooms	1928	7/15/66
Okra	12/18/28	
Onions, Bermuda-Granex-Grano Type	3/29/37	3/20/85
Onions, Creole	5/15/41	4/10/43
Onions, (Other Than Bermuda-Granex-Grano and Creole Types)	7/31/44	10/1/71
Onions, Common Green	6/20/47	
Onion Sets	6/1/35	2/1/40
Parsley	7/30/30	
Parsnips	12/10/45	
Peas, Fresh	2/1/34	6/1/42
Peas, Southern	7/13/56	
Peppers, Sweet	7/29/46	12/15/63
Potatoes	1917	2/5/72
Potatoes, Seed	4/29/72	
Radishes	7/16/54	10/1/68
Rhubarb (Field Grown)	3/10/33	2/1/66
Romaine	1928	8/10/60
Shallots, Bunched	12/16/46	
Spinach Leaves	12/27/46	
Spinach Plants	1931	11/19/56

Vegetables (Fresh Market)-Continued

	Established	Amended
Squash, Fall And Winter Type & Pumpkins	11/15/44	10/13/83
Squash, Summer	3/26/45	1/6/84
Sweetpotatoes	7/1/63	
Tomatoes, Fresh	9/3/34	4/15/76
Tomatoes, Greenhouse	4/19/66	
Turnips Or Rutabagas	8/1/55	
Watermelons	5/15/37	1/15/78

Vegetables (Fresh Market-Consumer)

Broccoli, Italian Sprouting	10/28/50	
Brussels Sprouts	9/19/50	
Carrots, (Bunched Topped, Short Trimmed Tops)	7/17/54	
Celery	3/27/49	
Corn (Husked on the Cob)	5/11/50	
Beet Greens	11/1/58	
Kale	8/26/50	
Parsnips	3/23/54	
Potatoes	12/8/47	
Spinach Leaves	5/19/49	
Tomatoes	10/10/48	
Turnips	8/20/54	

Vegetables For Processing

	Established	Amended
Asparagus, Green	2/15/41	4/5/72
Beans, Lima, Fresh Shelled	1/5/38	6/6/53
Beans, Snap	7/26/59	4/25/85
Beets	12/5/45	
Broccoli	4/29/51	10/4/59
Cabbage	1/17/44	
Carrots	1/17/44	7/30/84
Cauliflower	9/4/59	
Corn, Sweet	5/11/50	5/15/62
Cucumbers, Pickling	12/10/36	
Mushrooms	4/1/64	
Okra	12/15/65	
Onions	1/17/44	
Peas, Fresh Shelled, For Canning Or Freezing	1/15/46	
Peas, Southern	7/13/56	6/1/65
Peppers, Sweet	3/22/48	
Potatoes For Chipping	1/1/78	
Potatoes	6/15/37	4/14/83
Spinach	1931	7/10/56
Sweet Potatoes, For Canning Or Freezing	7/24/59	
Sweet Potatoes, For Dicing Or Pulping	7/23/51	
Tomatoes, Italian Type For Canning	5/7/57	
Tomatoes, Green	4/15/50	
Tomatoes	9/3/34	7/11/83

Fruit (Fresh Market)	Established	Amended
Apples	9/1/37	3/25/76
Apricots	5/25/28	
Avocados, Florida	9/3/57	
Blueberries	6/1/66	
Cherries, Sweet	1927	5/7/71
Cranberries, Fresh	8/26/71	
Dewberries And Blackberries	2/13/28	
Grapes, Bunch, American, (Eastern Type)	7/19/43	9/8/83
Grapes, Juice, (European Or Vinifera Type)	7/20/39	
Grapes, Table, (European Or Vinifera Type)	7/20/39	4/29/83
Grapefruit, (California And Arizona)	3/15/41	1/9/50
Grapefruit, Florida	9/14/52	12/1/80
Grapefruit, (Texas And States Other Than Florida, California, & Arizona)	11/3/55	10/1/69
Kiwifruit	9/9/82	
Lemons	3/15/41	9/1/64
Limes, Persian (Tahiti)	8/31/52	6/20/58
Nectarines	7/27/38	4/23/66
Oranges, (California And Arizona)	11/26/49	9/23/57
Oranges And Tangelos, Florida	10/14/55	12/1/80
Oranges, (Texas And States Other Than Florida, California And Arizona)	9/14/48	10/1/69
Peaches	4/22/33	6/15/52
Pears, Summer And Fall	6/27/40	8/20/55
Pears, Winter	7/8/40	9/10/55
Pineapples	12/4/31	2/23/53
Plums And Prunes, Fresh	5/31/45	6/30/73
Raspberries	5/29/31	
Strawberries	11/19/34	7/1/65
Tangerines	10/27/41	9/18/48
Tangerines, Florida	10/18/52	12/1/80
Fruit For Processing		
Apples	9/2/46	6/6/61
Berries	6/2/47	
Blueberries	9/5/50	
Cherries, Red Sour, For Manufacture	4/20/41	
Cherries, Sweet, For Canning Or Freezing	6/1/46	
Cherries, Sweet, For Export For Sulphur Brining	5/28/40	
Cranberries	8/24/57	
Currants	5/18/52	
Grapes, Bunch, American (Eastern Type) For Processing and Freezing	7/5/43	
Grapes, For Processing and Freezing	9/1/77	
Peaches, Freestone, For Canning, Freezing Or Pulping	5/4/42	6/1/66
Pears	7/1/70	
Raspberries	5/18/52	
Strawberries, Growers' Stock For Manufacture	6/1/35	
Strawberries, Washed And Sorted For Freezing	6/1/35	

Nuts and Special Products	Established	Amended
Almonds, Shelled	8/23/51	8/15/60
Almonds In The Shell	8/23/51	7/15/64
Asparagus Plumosus	6/6/30	
Brazil Nuts In the Shell	10/1/64	8/25/66
Christmas Trees	11/1/57	4/1/73
Filberts In The Shell	9/4/48	9/1/70
Gladiolus Corms (Bulbs)	4/5/82	
Mixed Nuts In The Shell	8/1/65	8/18/81
Peanuts, Shelled Spanish Type	9/1/39	7/15/65
Peanuts, Shelled Runner Type	9/1/39	7/31/56
Peanuts, Shelled Virginia Type	8/31/59	
Peanuts, Cleaned Virginia Type In The Shell	11/1/34	8/31/59
Pecans, Shelled	10/15/52	7/15/69
Pecans In The Shell	10/1/51	10/15/76
Peonies, Cut, In The Bud	4/1/38	
Tomato Plants	12/10/42	1/3/44
Walnuts, Shelled (<i>Juglans regia</i>)	1/25/59	9/1/68
Walnuts (<i>Juglans regia</i>) In The Shell	9/12/64	11/15/76

**U.S. Inspection
Instructions**

Write: Fresh Products Branch; USDA-AMS, FV; Room 2056-S, Washington, DC, 20250, to purchase copies of any of these instructions.

Market	Latest Issue	Cost
General	7/66	\$19.60
Almonds, Shelled	3/55	1.60
Apples	1/78	14.00
Bananas	1/73	3.10
Beans, Snap And Green Shell	3/55	1.30
Beets, Turnips And Rutabagas	10/77	4.50
Broccoli, Bunched Italian Sprouting	12/80	3.30
Brussels Sprouts	9/57	80
Cabbage	6/70	3.40
Cantaloups, Honeydew, Honey Ball And Other Similar Melons	9/67	4.20
Carrots, Bunched, And With Short-Trimmed Tops	3/56	2.70
Carrots, Topped	4/66	2.50
Cauliflower	2/70	2.10
Celery	9/65	2.80
Cherries, Sweet	7/71	3.90
Citrus, (Oranges-Grapefruit-Lemons) CA & AZ	1/65	5.60
Citrus, (Oranges-Grapefruit-Tangerines) FL	4/83	12.60
Citrus, (Oranges-Grapefruit)Texas And States Other Than FL, CA & AZ	10/69	4.30
Cranberries	10/72	3.00
Cucumbers	9/70	1.90
Eggplant	11/79	2.30

Market-Continued	Latest Issue	Cost
Garlic	7/56	1.50
Grapes	11/71	7.70
Greens (Beets, Broccoli, Collard, Dandelion, Mustard, Turnip)	11/56	1.00
Kiwifruit	10/82	2.30
Lettuce	3/76	5.30
Onions (Bermuda-Granex-Grano Type)	3/63	2.80
Onions (Other Than Bermuda-Granex- Grano And Creole Types)	6/78	6.10
Onion Sets	8/57	1.30
Ornamental Crops	3/74	3.60
Peaches	4/70	3.90
Pears	7/73	9.20
Peas, Fresh	9/56	1.80
Peppers, Sweet (Other Peppers)	1/81	7.50
Pineapples	9/54	1.60
Plums and Prunes	9/83	7.40
Potatoes	11/76	9.60
Shallots	9/54	1.00
Spinach Plants & Spinach Leaves	8/57	1.40
Spinach Leaves And Beet Greens On Basis of Consumer Standards	1/59	1.90
Sweet Anise, Parsnips, Radishes & Squash	10/59	5.00
Sweet Potatoes	12/64	2.60
Tomatoes	7/83	6.30
Watermelons	1/78	4.40
Miscellaneous Products, Artichokes, Coconuts Chestnuts, Horseradish Roots, Okra & Rhubarb	9/76	7.20
Combined Market And Shipping Point		
Almonds In The Shell	9/65	1.50
Apricots	9/75	2.80
Asparagus	1/72	4.00
Blueberries	6/66	1.00
Brazil Nuts In The Shell	6/73	2.40
Christmas Trees	7/76	2.50
Corn, Green	1/74	3.80
Filberts In the Shell	4/73	2.00
Limes, Persian (Tahiti) And Florida Avocados	11/65	4.50
Mushrooms	11/66	90
Nectarines	7/75	4.50
Peanuts, Milled (Shelled Stock And Cleaned Virginia Type In The Shell)	9/83	11.50
Pecans, Shelled	7/69	1.70
Pecans In The Shell	2/68	2.10
Strawberries And Other Berries	3/75	4.80
Walnuts, (<i>Juglans regia</i>) In The Shell And Shelled	12/74	6.30

Shipping Point	Latest Issue	Cost
General	1/66	14.00
Apples	7/78	16.10
Cabbage	11/73	3.10
Cantaloups, Honeydew, Honey Ball, And Other Similar Melons	4/67	3.40
Carrots	7/71	3.70
Cauliflower	7/69	1.60
Celery	9/57	3.10
Cherries, Sweet	5/71	3.60
Citrus, (Oranges & Grapefruit) Texas And States Other Than FL, CA, & AZ	10/78	6.90
Cucumbers	10/70	1.30
Eggplant	12/57	1.00
Kiwifruit	10/82	2.30
Lettuce	4/76	5.30
Onions (Bermuda-Granex-Grano Type) Onions (Other Than Bermuda-Granex- Grano And Creole Types)	5/62	3.40
Peaches	6/69	4.50
Peanuts, Farmers' Stock	7/84	10.70
Pears	7/84	5.30
Potatoes	4/78	12.00
Prunes, Italian Type (With Supple- ment for Plums) Amendment I	7/58	2.50
Sweet Potatoes	2/64	2.60
Tomatoes	1/85	5.50
Tomato Plants	8/55	2.80
Watermelons	3/78	3.90
Raw Products For Processing		
General	9/79	2.40
Apples	11/79	2.80
Beans, Fresh Shelled Lima	2/58	1.40
Beans, Snap	5/60	2.10
Berries	3/57	.80
Blueberries	10/56	.50
Broccoli	5/60	1.80
Carrots	4/60	1.30
Cauliflower	10/59	1.00
Cherries, Red Sour	9/60	.60
Corn, Sweet	6/62	1.90
Grapes for Processing And Freezing Mushrooms	11/81	4.40
Okra	11/62	.70
Okra	6/66	1.40
Peaches, For Canning, Freezing Or Pulping	6/66	1.00
Pears	12/70	1.60
Peas, Fresh Shelled For Canning or Freezing	9/56	2.00
Peas, Southern	6/66	1.20
Peppers, Sweet	10/56	1.50
Potatoes	7/83	5.30
Spinach	6/57	1.20
Sweetpotatoes	8/68	2.40
Tomatoes	7/83	4.20

Miscellaneous Instructions	Latest Issue	Cost
Apples, Pears and Grapes For Export	7/71	4.30
Canadian Import Requirements	2/79	5.40
Continuous Inspection	9/79	2.00
Supplies Purchased By Various Institutions	1/66	2.40
Inspection On Basis of U.S. Speci- fications For Classification of Damaged Or Repaired Packages	8/57	.80
Sampling Of In-Shell Brazil Nuts And Pistachio Nuts for Aflatoxin Analysis	11/72	1.10
Other		
Regulations Governing Inspection, Certification and Standards for Fresh Fruits, Vegetables, and Other Products	12/28/80	1.80
Uniform Grade Nomenclature Policy	7/1/76	.10

List of References

- (1) American President Companies. 1986. A handbook on shipping perishable commodities. 31 p. APC, Oakland, CA.
- (2) Ashby, B.H., R.T. Hinsch, L.A. Risse, W.G. Kindya, W.L. Craig, and M.T. Turczyn. 1987. Protecting perishable foods during transport by truck. U.S. Dept. Agr., Agr. Handb. 669, 94p.
- (3) Buishand, T, H.P. Houwing, and K. Jansen. 1986. The complete book of vegetables. 180 p. W.H. Smith Publishing Inc., New York, NY.
- (4) Conover C.A. and R.T. Poole. 1983. Handling and overseas transportation of acclimatized foliage plants in reefers. 3 p. Univ. Florida, Agr. Res. Center Res. Report RH-1983-1.
- (5) Debney, H.G., K.J. Blacker, B.J. Redding, J.B. Watkins. 1980. Handling and storage practices for fresh fruits and vegetables. Australian United Fresh Fruit and Vegetable Association.
- (6) Fibre Box Association. 1984. Fibre box handbook. 105 p. FBA, Chicago, IL.
- (7) Hardenburg, R.E., A.E. Watada, and C.Y. Wang. 1986. The commercial storage of fruits, vegetables, and florist and nursery stocks. U.S. Dept Agr., Agr. Handb. 66 (revised), 136p.
- (8) Kasmire, R.F. and R.T. Hinsch. 1982. Factors affecting transit temperatures in truck shipments of fresh produce. 10 p. Univ. CA, Davis.
- (9) Langefeld, J. 1985. Shipping foliage plants. Grower Talks: 74-86.
- (10) Lipton, W.J. and J.M. Harvey. 1977. Compatibility of fruits and vegetables during transport in mixed loads. U.S. Dept. Agr., Mktg. Res. Report 1070, 7 p.
- (11) Martin, F.W., ed. 1984. Handbook of tropical food crops. 296 p. CRC Press, Inc., Boca Raton, FL.
- (12) Maxwell, L.S. and B.M. Maxwell. 1981. Florida fruit. 120 p. Lewis S. Maxwell. Tampa, FL.
- (13) Maxwell, L.S. and B.M. Maxwell. 1984. Florida vegetables. 120 p. Lewis S. Maxwell. Tampa, FL.
- (14) Nicholas, C.J. 1985. Export handbook for U.S. agricultural products. U.S. Dept. Agr., Agr. Handb. 593 (revised), 154p.
- (15) Ortho Books. 1985. All about citrus and subtropical fruit. 96 p. Chevron Chemical Co., San Francisco, CA.
- (16) The Packer. The Packer 1986 produce availability and merchandising guide. 1986. Vol. 93, No. 53. 376 p. The Packer, Shawnee Mission, KS.

- (17) Pantastico, E.B. 1975. Postharvest physiology, handling and utilization of tropical and subtropical fruits and vegetables. AVI Pub. Co., Westport, CT.
- (18) Pijpers, D., J.C. Constant, and K. Jansen. 1985. The complete book of fruit. 179 p. W.H. Smith Publishers Inc. New York, NY.
- (19) Poole, R.T. and C.A. Conover. 1983. Packaging of foliage plants for shipment. 3 p. Univ. Florida, ARC Res, Report RH-83-6.
- (20) Produce Marketing Association. 1985. The foodservice guide to fresh produce. 48 p. PMA, Newark, DE.
- (21) Rij, R.E., J.F. Thompson, and D.S. Farnham. 1979. Handling, precooling, and temperature management of cut flower crops for truck transportation. U.S. Dept. Agr., Adv. Agr. Tech. Bull. W-5. 26 p.
- (22) Risse, L.A., W.R. Miller, and T. Moffitt. 1982. Shipping fresh fruits and vegetables in mixed loads to the Caribbean. 10 p. U.S. Dept. Agr., Adv. Agr. Tech. Bull. AAT-S-27.
- (23) Ryall, A.L., and W.J. Lipton. 1979. Handling, transportation and storage of fruits and vegetables. Vol. 1. Vegetables and melons. 2d ed. 610 p. AVI Pub. Co. Westport, CT.
- (24) Ryall, A.L., and W.T. Pentzer. 1982. Handling, transportation, and storage of fruits and vegetables. Vol. 2. Fruits and tree nuts. 2d ed. 610 p. AVI Pub. Co., Westport, CT.
- (25) Safeway Stores, Inc. 1986. Transit and storage properties of produce commodities. 1 p. Produce Marketing Association, Newark, DE.
- (26) Sea-Land Service, Inc. 1984. The shipping of perishables, Sea-Land's commitment to excellence. 19 p. Sea-Land Service, Inc., Elizabeth, NJ.
- (27) Society of American Florists. 1985. Care and handling of flowers and plants. 159 p. SAF, Alexandria, VA.
- (28) Society of American Florists and the Produce Marketing Association. 1986. Box standards for the floral industry. SAF, Alexandria, VA.
- (29) Turczyn, M.T. and J.P. Anthony. 1983. MUM replacement containers. 3 p. UFFVA, Alexandria, VA.
- (30) United Fresh Fruit and Vegetable Association. 1986. Fruit and vegetable facts and pointers, and container net weights. UFFVA, Alexandria, VA.
- (31) United States Office of International Cooperation and Development. 1985. Agricultural marketing handbook for Caribbean Basin products. U.S. Dept. Agr., Office of Intnatl. Coop. & Developmt., 200 p.